



JBL CINEMA SB450



 DOLBY AUDIO™

 **HDMI**®
HIGH-DEFINITION MULTIMEDIA INTERFACE

 Bluetooth®

OWNER'S MANUAL

TABLE OF CONTENTS

INTRODUCTION	3
INCLUDED ITEMS	3
TOP PANEL CONTROLS AND REMOTE CONTROL	3
SOUNDBAR REAR PANEL CONNECTIONS AND CONTROLS	4
SUBWOOFER REAR PANEL CONNECTIONS AND CONTROLS	5
SOUNDBAR PLACEMENT	5
PLACING THE SOUNDBAR ON A TABLE	5
WALL-MOUNTING THE SOUNDBAR	5
SUBWOOFER PLACEMENT	6
CONNECTIONS	6
SOUNDBAR AUDIO/VIDEO CONNECTIONS	6
POWER CONNECTIONS	7
USING YOUR SOUNDBAR SYSTEM	7
TURNING THE SOUNDBAR ON AND OFF	7
TURNING THE SUBWOOFER ON AND OFF	7
Pairing the Units for Wireless Operation	7
SWITCHING SOURCES	7
ADJUSTING THE SYSTEM'S VOLUME	7
MUTING THE SYSTEM	8
USING BLUETOOTH	8
USING JBL SOUNDSHIFT™	8
USING JBL CONNECT	8
USING AUDIO FEEDBACK	9
USING VIRTUAL SURROUND	9
USING HARMAN VOLUME	9
ADJUSTING THE BASS	9
SUBWOOFER LEVEL CONTROL	9
SUBWOOFER CROSSOVER CONTROL	10
SUBWOOFER PHASE SWITCH	10
USING YOUR OWN TV REMOTE (TV REMOTE CONTROL LEARNING)	10
RESETTING THE SOUNDBAR	10
TROUBLESHOOTING	11

INTRODUCTION

Thank you for purchasing the JBL Cinema SB450. The JBL Cinema SB450 is designed to bring an extraordinary sound experience to your home entertainment system. We urge you to take a few minutes to read through this manual, which describes the product and includes step-by-step instructions to help you set up and get started.

CONTACT US: If you have any questions about JBL Cinema SB450, its installation or its operation, please contact your retailer or custom installer, or visit our website at: www.JBL.com.

INCLUDED ITEMS

Soundbar



x1

Wireless Subwoofer

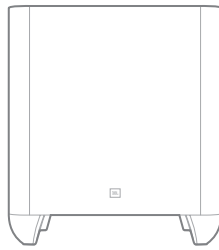

x1

Remote Control



x1

Optical Cable (5ft, 1500mm)



x1

HDMI Cable (3ft, 1000mm)



x1

(2) Power Cables (5ft, 1500mm)



x1



x1

Wall Mount Bracket

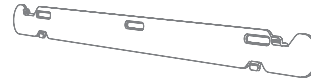

x1

Quick Start Guide

x1

TOP PANEL CONTROLS AND REMOTE CONTROL

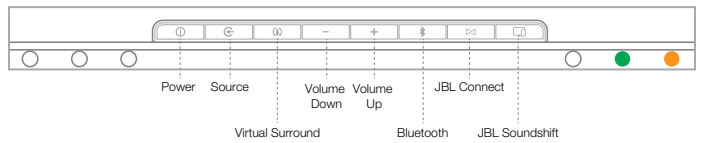

SOURCE LED BEHAVIOR	
● HDMI 1/2/3	● Aux
● HDMI TV	● Optical

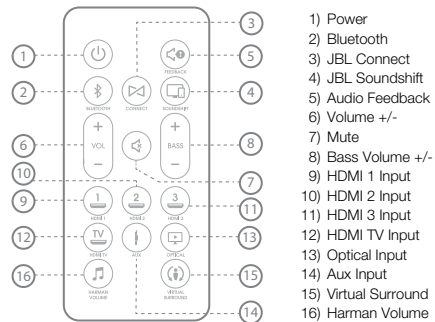

Note: Before using the remote control, remove the plastic tab protecting the battery at the bottom of the remote control.

Power: Press this button to turn the system on when the soundbar is in Standby mode,(The Power indicator will turn white.) To put the system in Standby mode, press the Power button while the system is on. (The Power indicator will turn amber.)

NOTE: The soundbar will automatically go into Standby mode after 10 minutes of inactivity. For more information, see the "Turning the Soundbar On and Off" section.

Source: Press this top-panel button to cycle between the sources in the following order: HDMI 1, HDMI 2, HDMI 3, HDMI TV, Aux and Optical. The active Source Indicator LED will illuminate. The remote has an individual selector button for each source.

Virtual Surround: Press this button to turn the soundbar's HARMAN Display Surround processing on and off. The Virtual Surround button indicator turns white when HARMAN Display Surround is active. See the "Virtual Surround" section for more information.

Volume Buttons: Press the "+" button to increase the volume; press the "-" button to decrease the volume.

Bass Level Control (remote control only): Press these buttons to adjust the overall level of the subwoofer to your preference.

Harman Volume (remote control only): Press this button to activate Harman Volume. This feature helps to maintain the volume level constant and minimizes big variations in volume level when listening to music or watching television. See the “Using Harman Volume” section for more information.

Audio Feedback (remote control only): Press this button to activate Audio Feedback. This feature provides audible tones to indicate when certain functions are active. See the “Using Audio Feedback section” for more information.

Mute (remote control only): Press the Mute button to mute the system. (The top-panel Power LED indicator will blink white.) While the system is muted, press the Mute button again or either Volume button to restore the sound.

NOTE: Pressing both of the soundbar’s top-panel Volume buttons at the same time while the system is on will mute the system. Pressing either Volume button while the system is muted will restore the sound.

Bluetooth: Press this button to play the audio stream from a paired Bluetooth device through the soundbar. (The Bluetooth Source Indicator LED will illuminate when a paired Bluetooth device is the active source.) Press and hold this button to force the soundbar into the Bluetooth pairing mode. See the “Using Bluetooth” Section for more information.

JBL Connect: Press this button to engage JBL Connect pairing mode. JBL Connect creates a Bluetooth wireless connection with other compatible JBL Connect products. See “Using JBL Connect” section for more information.

JBL SoundShift®: Press this button to engage JBL SoundShift. JBL SoundShift allows you to instantly switch between sound from your TV and sound from your phone or tablet. See the “Using JBL SoundShift” section for more information.

SOUNDBAR REAR PANEL CONNECTIONS AND CONTROLS

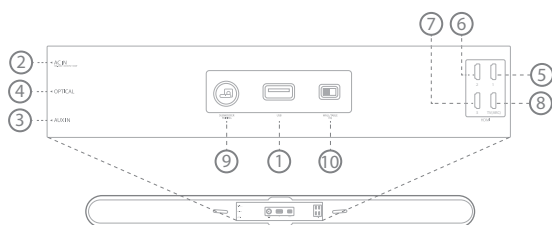

- | | |
|--------------------------------|--|
| 1) USB (Software updates only) | 6) HDMI 2 |
| 2) Power In | 7) HDMI 3 |
| 3) Aux IN | 8) HDMI TV |
| 4) Optical IN | 9) Subwoofer pairing button |
| 5) HDMI 1 | 10) Wall Mount / Table Mount EQ switch |

Power Input: Connect the included power cord here. See the “Power Connections” section for more information.

Optical: If your TV, disc player or cable/satellite tuner has an optical digital output, use the included optical cable to connect it here.

Aux: Use a 3.5mm audio cable to connect the stereo analog outputs of your TV, disc player or cable/satellite tuner here.

HDMI 1/2/3: HDMI connections transmit digital audio and video signals between devices. If you have source devices with HDMI connectors, using them will provide the best possible audio and video performance quality.

HDMI TV: If your TV has an HDMI input, use the provided HDMI cable to connect it to the soundbar’s HDMI ARC TV Out connector. The soundbar will pass video from source devices connected to its HDMI Input connectors. If your TV is equipped with the HDMI Audio Return Channel (ARC) Function, you can feed its sound to the soundbar via the HDMI ARC TV Out connection, and it will not require additional audio connections to the soundbar. The ARC signal is active when the HDMI TV source is selected.)

Subwoofer Pairing Button: Press the Pairing button to initiate wireless pairing between the soundbar and the wireless subwoofer. See the “Pairing the Units for Wireless Operation” section for more information.

Wall-Mount/Table-Mount EQ Switch: Use this switch to adjust the soundbar’s equalization (EQ) for either wall or table mounting. If you’re mounting the soundbar on a wall with the included wall-mount bracket, set the EQ switch to the “Wall” position for the most natural-sounding bass performance. If you are placing the soundbar on a table, set the EQ switch to the “Table” position for the most natural-sounding bass performance.

Software: The USB connection is for manual software updates only. If a new software update is released, JBL will notify you if your product is registered at www.JBL.com

IMPORTANT: Do not connect the power cord to an AC outlet until you have made and verified all other connections.

SUBWOOFER REAR PANEL CONNECTIONS AND CONTROLS

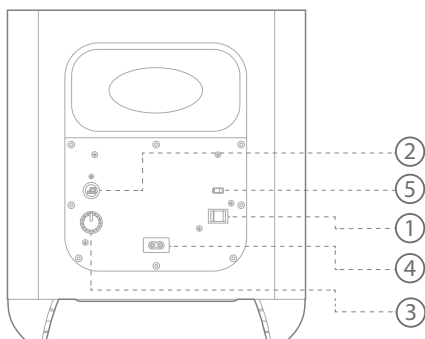

- 1) Power
- 2) Wireless Pairing Button
- 3) Crossover
- 4) Power Input AC
- 5) Phase

Attention: Your JBL CINEMA SB450 comes with subwoofer already paired from the factory, please refer to the subwoofer connection section of this owner's manual only if you are experiencing no audio output from your subwoofer after connecting it to the power.

Wireless Pairing: Press this button to initiate wireless pairing between the subwoofer and the soundbar. The LED lights white continuously when the subwoofer is on and linked to the soundbar. The LED slowly flashes white when the subwoofer is on and the wireless link is not established between the subwoofer and the soundbar. The LED rapidly flashes white during the wireless pairing process.

Phase Control: This switch determines whether the subwoofer driver's piston-like action moves in and out in phase with the speakers in the soundbar. If the subwoofer were to play out of phase with the soundbar speakers, some of the sound waves produced by the subwoofer or soundbar could be canceled, reducing bass performance and sonic impact. This phenomenon depends in part on the relative placement of the speakers in the room. See the "Subwoofer Phase Switch" section for more information.

Crossover: This knob adjusts the subwoofer's cutoff between 40Hz and 200Hz. The higher you set the Cutoff control, the higher in frequency the subwoofer will operate and the more its bass will "overlap" that of the soundbar. This adjustment helps achieve a smooth transition of bass frequencies between the subwoofer and the soundbar for a variety of different rooms and subwoofer locations. See the "Subwoofer Crossover Control" section for more information.

Power Cord Connector Connect the included power cord here and into an active, unswitched AC outlet. See Power Connections for more information.

IMPORTANT: Do not connect the power cord to an AC outlet until you have made and verified all other connections.

SOUNDBAR PLACEMENT

PLACING THE SOUNDBAR ON A TABLE

If your TV is placed on a table, you can place the soundbar on the table directly in front of the TV stand, centered with the TV screen. As long as the surface of the table is flat, the soundbar will rest on its metal feet. Set the soundbar's EQ switch in the "Table" position. See Soundbar Rear-Panel Controls and Connections.

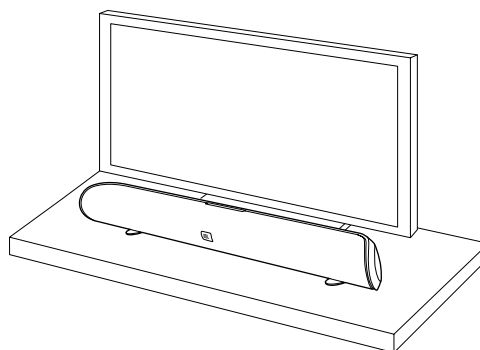

WALL-MOUNTING THE SOUNDBAR

If your TV is attached to a wall, you can use the included wall-mount bracket to mount the soundbar on the wall directly below the TV screen.

1. Determine the location for the soundbar on the wall. Make sure that the top of the soundbar will not block your view of the TV screen when it is mounted on the wall.
2. Hold the bracket against the wall as a template and mark the locations of the soundbar wall-mount bracket holes on the wall. The three holes should be evenly spaced 7-1/16" (18cm) apart, and the bracket slots are designed to accept 4mm screws. Make sure that the holes are at the same height. See the illustration below.

Mark Three Bracket Hole Locations
7-1/16" (18cm) Apart

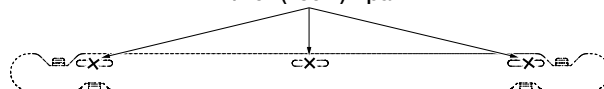

3. Making sure that the bracket's flat side is against the wall, attach the wall-mount bracket to the wall at the locations you marked, using hardware that is appropriate for the wall's construction and materials. Note that the soundbar weighs 7.5 lb (3.4kg). Be sure to use hardware that can support this weight.

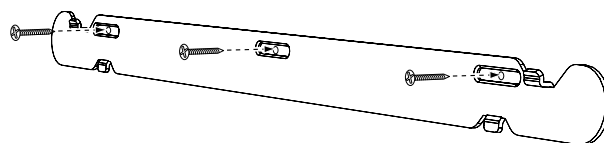

After reading the Connections section, connect all cables to the soundbar.

IMPORTANT: Do not plug the soundbar's power cord into an AC outlet at this time.

4. Set the soundbar's EQ switch in the "Wall" position.
5. Attach the soundbar to the bracket by sliding the bracket's upper tabs into the slots on the back of the soundbar. The soundbar's slots allow you to adjust the soundbar's angle on the wall to ensure that it is level.

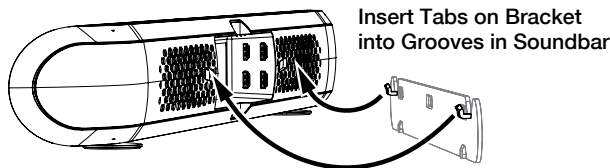

6. After reading the Connections section, connect all cables to the soundbar.

SUBWOOFER PLACEMENT

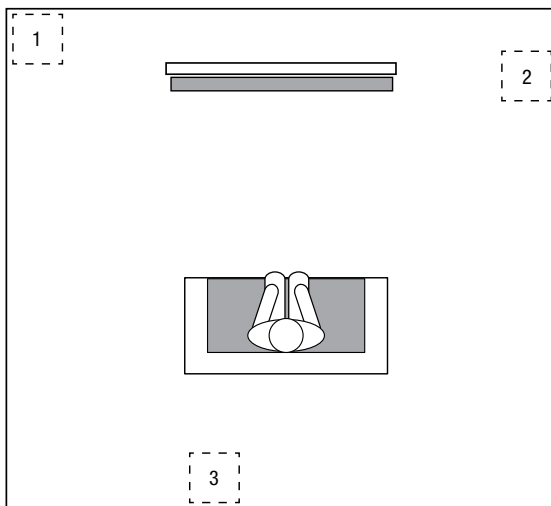

The performance of a subwoofer is directly related to its placement in the listening room and its physical position relative to the other speakers in the system. For example, placing it in a corner (1) generally will maximize the amount of bass in the room. In many rooms, placing the subwoofer along the same plane as the soundbar (2) can produce the best integration between the sound of the subwoofer and that of the soundbar. In some rooms, the best performance could even result from placing the subwoofer behind the listening position (3). We strongly recommend that you experiment with placement before choosing a final location for your subwoofer.

CONNECTIONS

SOUNDBAR AUDIO/VIDEO CONNECTIONS

HDMI ARC TV Out: If your TV has an HDMI input, use the included HDMI cable to connect it to the soundbar's HDMI ARC

TV Out connection. The soundbar will pass video from source devices to the TV. If your TV is equipped with the HDMI Audio Return Channel (ARC) Function, you can feed its sound to the soundbar via the HDMI ARC TV Out connection, and it will not require additional audio connections to the soundbar. The ARC signal is active when the HDMI TV source is selected.

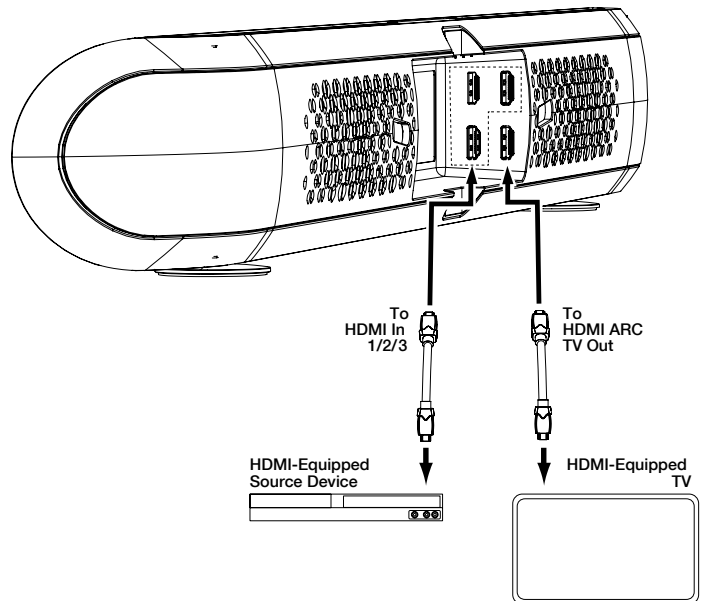

HDMI In 1/2/3: If any of your source devices have HDMI connectors, connect them to the soundbar's HDMI In 1/2/3 connectors for the best possible video and audio performance quality. Since the HDMI cable carries both digital video and digital audio signals, you do not have to make any additional audio connections for source devices you connect via HDMI connectors.

NOTE: The JBL CINEMA SB450 supports HDCP 2.2 on all its HDMI inputs and output, meaning that you can connect directly any 4K ultra HD source to your soundbar. Please refer to your television owner's manual to ensure that it is also supports HDCP 2.2 as otherwise any 4K content with HDCP 2.2 copy protected content will automatically be downscaled to full HD on your television even if it is 4k compatible.

Aux In and Optical In connections: If your TV and source devices do not have HDMI connections, you can use the supplied audio cable and optical cable to connect your TV and one source device to the soundbar's Aux In and Optical In connectors, respectively.

NOTE: The Optical Input does not support all digital audio and surround sound formats. If the optical input receives an unsupported audio format, there may be a sound dropout. The HDMI Input will automatically detect and resolve unsupported audio formats. If you experience sound dropouts with the optical connection, it is recommended to change the audio output format on the source device to PCM or use an HDMI connection from your source to the soundbar.

POWER CONNECTIONS

After verifying that all of the source connections have been made properly, plug the supplied power cords into the soundbar's and subwoofer's Power Cord connectors, and plug the other ends into active, unswitched AC outlets. Do NOT plug this cords into the accessory outlet found on some audio components.

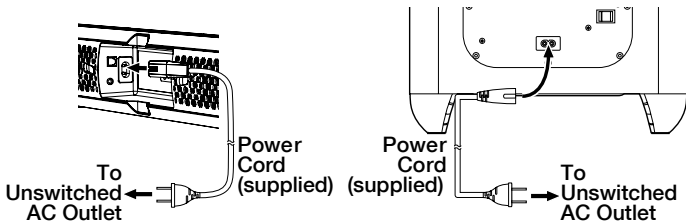

USING YOUR SOUNDBAR SYSTEM

TURNING THE SOUNDBAR ON AND OFF

Press the Power button on either the soundbar or the remote control to turn the soundbar on. To put the soundbar in the Standby mode, press either Power button while the soundbar is on.

If you have manually put the soundbar into the Standby mode by pressing the Power button, you can turn it back on by:

1. Pressing the Power button again
2. Streaming music from a connected Bluetooth device

The soundbar will automatically go into the Standby mode after 10 minutes of inactivity. If the soundbar has automatically gone into the Standby mode, it will automatically turn itself on again when it receives an audio signal from the last detected connection.

NOTE: You can control the soundbar with your own TV remote control. See the “Using Your Own TV Remote (TV Remote Learning)” section for more information.

TURNING THE SUBWOOFER ON AND OFF

Set the subwoofer's Power switch to the “On” position. Once the subwoofer and soundbar have been paired (see Pairing the Units for Wireless Operation, below) the subwoofer will turn on when the soundbar turns on and will remain on for approximately 30 seconds after the soundbar enters the Standby mode, or for approximately 10 minutes after the audio signal ceases. If you will be away from home for an extended period of time, or if you will not be using the system for an extended period, set the subwoofer's Power switch to the “Off” position.

Pairing the Units for Wireless Operation

The JBL Cinema SB450 soundbar and wireless subwoofer are automatically “paired” with each other. If the system does not connect right away, press the Wireless Pairing buttons on both units within 30 seconds of each other. The units will communicate with each other and operate at the same frequency.

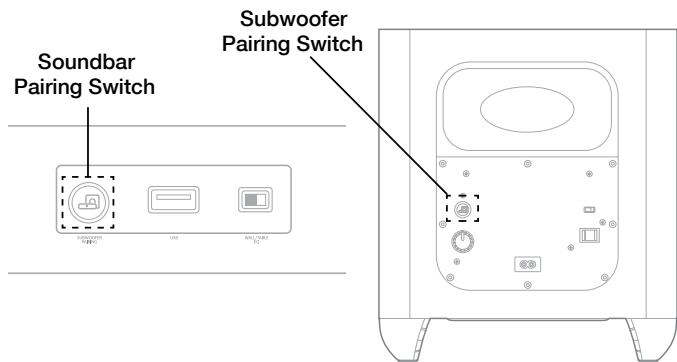

NOTE: The maximum wireless operating distance between the soundbar and subwoofer is approximately 30 feet (10m).

SWITCHING SOURCES

You may select any of the devices that are connected to the soundbar by pressing the corresponding button on the JBL Cinema SB450 remote control or pressing the source button on the top button panel. The active source's Source Indicator LED will illuminate.

If you have connected devices directly to your TV's input connections AND you have connected the soundbar to your TV's HDMI ARC input, then audio will flow from the TV to the soundbar.

1. Press the HDMI TV button on the JBL SB450 remote control to select audio from your TV.
2. Use your TV remote control to select the corresponding input source device—this may be with an “INPUT” or “SOURCE” button. Refer to your TV settings and operation.

ADJUSTING THE SYSTEM'S VOLUME

Press the soundbar's or remote's Volume + and – buttons to raise and lower the system's volume one step at a time. Hold down the buttons to continuously raise or lower the volume. For the best sound, we recommend turning your TV's built-in speakers off. Consult your TV's owner's manual to find out how to do this.

Note: You can control the soundbar with your own TV remote control. See the “Using Your Own TV Remote (TV Remote Learning)” section for more information.

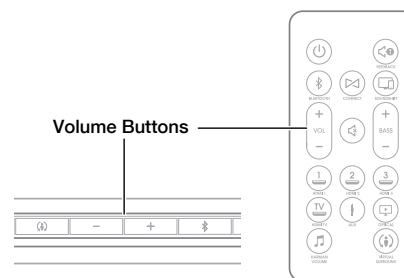

MUTING THE SYSTEM

Momentarily press both of the soundbar's top-panel volume buttons at the same time, or press the remote control's Mute button to mute the system. (The Power LED flashes.) Momentarily press either of the soundbar's Volume buttons or press the remote's Mute button again to un-mute the system.

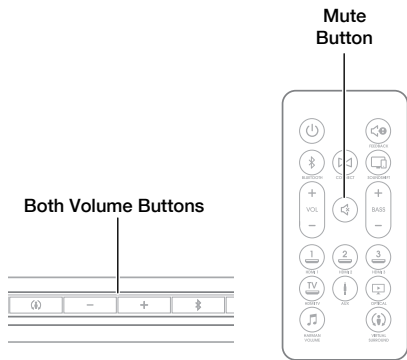

USING BLUETOOTH

Bluetooth is a wireless connection that will help you to stream any music from your mobile device to your soundbar. You can pair up to 3 Bluetooth devices at the same time.

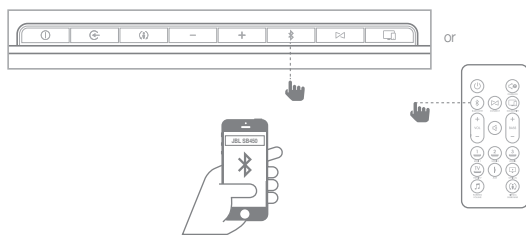

LED BEHAVIOR	
	Bluetooth Pairing
	Bluetooth Paired

1. Press and hold the Bluetooth button for 3 seconds to enter pairing mode (the button LED will quickly flash blue).
2. Open your Bluetooth settings on your mobile device, then locate and select JBL CINEMA SB450.
3. Test the connection by streaming music from your device to your JBL Cinema SB450.
4. To add an additional Bluetooth device (up to 3), repeat steps 1 & 2.

NOTE: If you have more than one Bluetooth device paired at one time, one device may interrupt/override another device simply by pressing "PLAY".

USING JBL SOUNDSHIFT™

JBL SoundShift is a new technology that allows you to seamlessly switch between your TV and your wireless Bluetooth device. This helps to you watch TV and use your Bluetooth device at the same

time without reaching for the remote control to switch between the two devices.

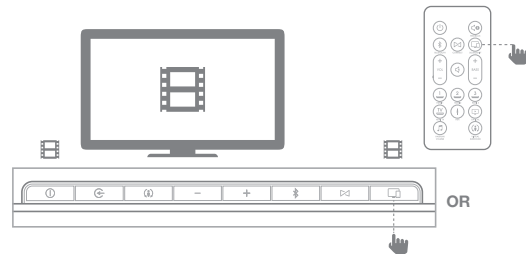

LED BEHAVIOR	
	Soundshift is off
	Soundshift is on

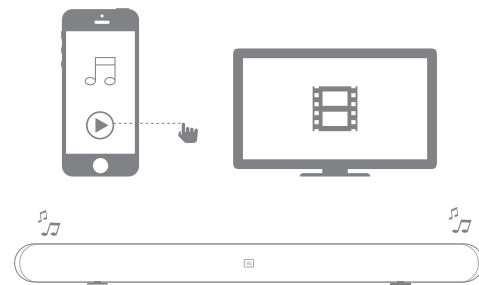

1. Confirm that you have paired at least one Bluetooth device to the soundbar (See "Using Bluetooth" section).
2. Press the JBL SoundShift button on the Remote Control or Top-panel buttons until the LED turns BLUE. This color indicates that JBL SoundShift is ON.
3. Play sound from any source through your soundbar in a normal manner.
4. Press PLAY on your mobile device to stream music. You will hear the Bluetooth audio "break in" over your TV sound.
5. Press PAUSE on your mobile device. You will hear the audio automatically switch back to your TV.

USING JBL CONNECT

JBL Connect lets you wirelessly daisy chain two speakers. JBL Connect requires an additional compatible speaker like JBL Flip 3, JBL Xtreme, or JBL Pulse 2. For more information, please visit our website at www.jbl.com

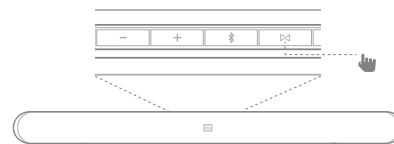

1. Confirm that you have paired at least one Bluetooth device to the soundbar
2. Press the JBL Connect button on the remote control or the top-panel button (LED will blink white).

3. Press the JBL Connect button on your other JBL speaker. Once the soundbar and secondary JBL speaker are connected, the LED will turn solid white.
4. Stream music from your wireless device. You will hear sound on both speakers
5. The volume is synchronized between the two devices—turning the volume up or down on one device will affect the other.
6. To disable JBL Connect, turn off the second device.

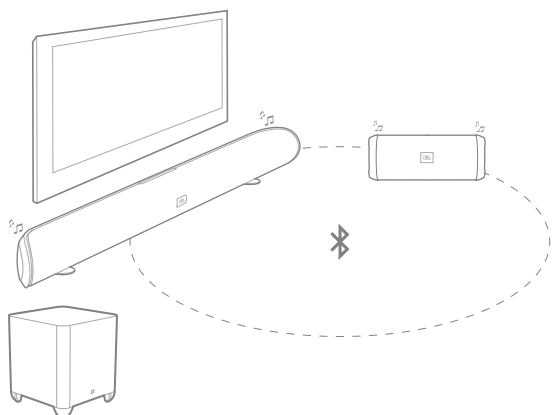

LED BEHAVIOR	
	Seeking JBL Connect Speaker
	Paired with JBL Connect Speaker

NOTE: JBL Connect supports Bluetooth audio streaming only. Audio from the wired TV input will not stream to the second JBL device.

USING AUDIO FEEDBACK

Audio feedback enables audible tones indicate certain product features. When Audio feedback is ON, you will hear tones for specific actions on the JBL Cinema SB450:

1. Bluetooth Pairing is ON.
2. Bluetooth device is connected
3. JBL Connect pairing is ON
4. JBL Connect device is connected
5. JBL SoundShift On/Off
6. Harman Volume On/Off

USING VIRTUAL SURROUND

LED BEHAVIOR	
	Virtual Surround ON
	Virtual Surround OFF

Harman Display Surround brings rich virtual surround sound to your home entertainment experience. Turn Harman Virtual Surround ON when you are watching movies for a wide, spacious sound effect.

Press the soundbar’s or remote’s Surround Mode button to switch the sound between normal stereo and Harman Display Surround (the Surround Mode indicator lights white). The Harman Display Surround setting will produce a complete surround-sound experience for anyone sitting in front of and several feet away from the soundbar. Although it is particularly effective when watching movies, you can also try the Harman Display Surround setting for music.

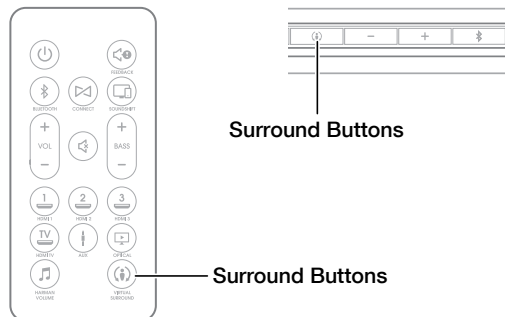

USING HARMAN VOLUME

Harman Volume reduces major volume differences between soft and loud in content and maintains a more uniform volume level. Turn Harman Volume ON when watching TV with commercials or late-night movies. To turn Harman Volume ON, press the button on the remote control.

NOTE: Turn Audio Feedback ON with the remote control to hear an audible indication for Harman Volume ON/OFF settings

ADJUSTING THE BASS

SUBWOOFER LEVEL CONTROL

Press the Bass Level +/- buttons on the remote control to adjust the bass level to your preference.

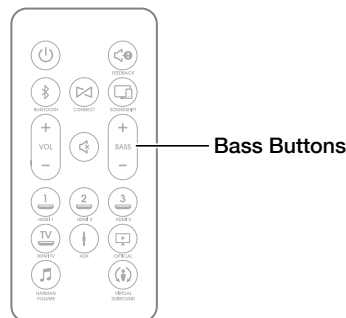

SUBWOOFER CROSSOVER CONTROL

The subwoofer's Crossover control adjusts the subwoofer's cutoff between 40Hz and 200Hz. The higher you set the Crossover control, the higher in frequency the subwoofer will operate and the more its bass will "overlap" that of the soundbar. This adjustment helps achieve a smooth transition of bass frequencies between the subwoofer and the soundbar for a variety of different rooms and subwoofer locations. To set the Crossover control, listen for the smoothness of the bass. If the bass seems too strong at certain frequencies, try a lower Crossover control setting. If the bass seems too weak at certain frequencies, try a higher Crossover control setting.

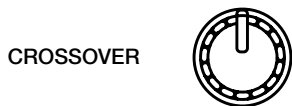

SUBWOOFER PHASE SWITCH

This switch determines whether the subwoofer's piston-like action moves in and out in phase with the speakers in the soundbar. If the subwoofer were to play out of phase with the soundbar speakers, some of the sound waves produced by the soundbar and subwoofer could be canceled out at some frequencies, reducing bass performance and sonic impact. This phenomenon depends in part on the relative placement of the soundbar and subwoofer in the room. Although there is no absolutely correct setting for the Phase switch, in most cases it should be left in the "0°" position. When the subwoofer is properly in phase with the soundbar speakers, the sound will be clearer and have more impact. It will make percussive sounds like drums, piano and plucked strings sound more lifelike. The best way to set the Phase switch is to listen to music that you are familiar with and adjust the switch so that drums and other percussive sounds have maximum impact.



USING YOUR OWN TV REMOTE (TV REMOTE CONTROL LEARNING)

If you are using an HDMI ARC connection to your television, then your TV remote control will automatically operate the soundbar for standard commands such as power on/off and volume control. The JBL CINEMA SB450 supports HDMI CEC and will interoperate with compatible TV's (check your TV owner's manual for HDMI CEC compatibility)

If your TV does not support HDMI CEC volume and power control another option is to program the soundbar to be controlled by your TV remote control. For example, when you press POWER ON, you will turn on your TV and soundbar at the same time. This simplifies your system helps you keep your TV and speaker in sync.

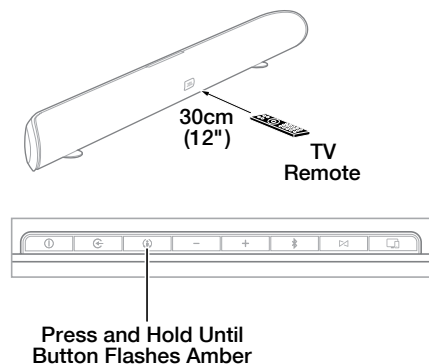

1. Confirm that soundbar is ON
2. Press and hold the top-panel Harman Display Surround Button for 5 seconds until the power LED flashes amber. If the LED does not flash, release the button and try again.
3. Press the soundbar top-panel VOLUME UP button
4. Aim the TV remote at the front of the JBL Cinema SB450 and slowly press the VOLUME UP button on the TV remote until the Harman Display Surround button flashes white for one second. This indicates that the programming operation has been successful.
5. Repeat steps 3 and 4 for VOLUME DOWN, POWER, and MUTE (to mute the JBL Cinema SB450, press VOLUME UP and VOLUME DOWN buttons at the same time).
6. To exit the learning mode (at any time or when the learning is complete), press and hold the Harman Display Surround button until the amber LED stops flashing.

RESETING THE SOUNDBAR

The JBL Cinema SB450 can be reset to its default factory settings and erasing all programming.

To reset the soundbar, press and hold Volume+ and Virtual Surround buttons for 5s.

TROUBLESHOOTING

If your JBL Cinema SB450 does not perform the way you think it should, check whether the problem is covered in this section before contacting your dealer or a JBL representative.

Problems	Solutions
If the speaker does not turn ON	<ul style="list-style-type: none"> Check if the speaker AC power cord is plugged into a working AC outlet and that the cable is plugged into the speaker.
If there is no sound coming from the speaker	<ul style="list-style-type: none"> Check the power is set to ON, then check to see if the volume is turned up. Check if your TV has certain settings to enable the audio connection, or try to connect another source.
If there is NO sound from the system, even when the speaker's volume is turned all the way up	<ul style="list-style-type: none"> If the TV or source component is connected via a variable output, check its instructions if the output is not turned down too low, or try to connect to another source.
If there is no picture on the TV Screen	<ul style="list-style-type: none"> Check that the soundbar power is ON, the intended source is ON, and the input is set correctly on the soundbar.
The subwoofer is not playing	<ul style="list-style-type: none"> Check that the power is ON, and that the subwoofer is correctly paired to the soundbar.
There is no sound using the optical input	<ul style="list-style-type: none"> Optical input does not support all surround sound formats. JBL recommend to use HDMI connection if other sound formats are used.

SPECIFICATIONS

Total Cinema SB450 Amplifier Power: 440W

Max SPL: 103dB

Frequency Response: 40Hz-20kHz

HDMI Video Inputs: 3

HDMI Video Output (with Audio Return Channel): 1

Bluetooth Version: 3.0

Max Bluetooth Range: 32 ft (10m)

Soundbar Amplifier Power: 240W

Soundbar Transducer Size: 2.25" (58mm)

Soundbar Dimensions (L x W x H): 44" x 3" x 4" (1100 x 76 x 97mm)

Soundbar Weight: 7.5lbs (3.4kg)

Soundbar Power Consumption (standby): <0.5W

Soundbar Power Consumption (max): 60W

Subwoofer Amplifier Power: 200W

Subwoofer Transducer Size: 8" (200mm)

Subwoofer Dimensions (L x W x H): 13" x 13" x 14" (320 x 320 x 355.5mm)

Subwoofer Weight: 21lbs (9.5kg)

Subwoofer Power Consumption (standby): <0.5W

Subwoofer Power Consumption (max): 100W

Packaging Dimensions (L x W x H): 46" x 16" x 19" (1210 x 395 x 520mm)

Packaging Weight (Gross): 35lbs (16kg)

Торговая марка : JBL
 Назначение товара : Активная акустическая система
 Изготовитель : Харман Интернешнл Индастриз Инкорпорейтед, США, 06901 Коннектикут, г.Стэмфорд, Атлантик Стрит 400, офис 1500
 Страна происхождения : Китай
 Импортер в Россию : ООО «ХАРМАН РУС СиАйЭс», Россия, 127018, г.Москва, ул. Двинцев, д.12, к 1
 Гарантийный период : 1 год
 Информация о сервисных центрах : www.harman.com/ru тел. +7-800-700-0467
 Срок службы : 5 лет
 Товар сертифицирован : 
 Дата производства : Дата изготовления устройства определяется по двум буквенным обозначениям из второй группы символов серийного номера изделия, следующих после разделительного знака «-». Кодировка соответствует порядку букв латинского алфавита, начиная с января 2010 года: 000000-MY0000000, где «М» - месяц производства (А - январь, В - февраль, С - март и т.д.) и «Y» - год производства (А - 2010, В - 2011, С - 2012 и т.д.).



HARMAN International Industries,
 Incorporated 8500 Balboa
 Boulevard, Northridge, CA 91329
 USA
www.jbl.com

© 2016 HARMAN International Industries, Incorporated. All rights reserved. JBL is a trademark of HARMAN International Industries, Incorporated, registered in the United States and/or other countries. Features, specifications and appearance are subject to change without notice. The Bluetooth® word mark and logos are registered trademarks owned by Bluetooth SIG, Inc. and any use of such marks by HARMAN International Industries, Incorporated is under license. Other trademarks and trade names are those of their respective owners. The terms HDMI, the HDMI logo, and High-Definition Multimedia Interface are trademarks or registered trademarks of HDMI Licensing LLC in the United States and other countries. Manufactured under license from Dolby Laboratories. Dolby, Dolby Audio and the double-D symbol are trademarks of Dolby Laboratories.

TR03305_A