



US00D635004S

(12) **United States Design Patent**
Rivera et al.

(10) **Patent No.:** **US D635,004 S**

(45) **Date of Patent:** **** Mar. 29, 2011**

(54) **HAND TOOL**

(75) Inventors: **Benjamin C. Rivera**, Lake Oswego, OR (US); **Jeffrey L. Caniparoli**, Milwaukie, OR (US); **Jeffrey B. Castro**, Portland, OR (US); **Blair Scott Barnes**, Portland, OR (US)

(73) Assignee: **Leatherman Tool Group, Inc.**, Portland, OR (US)

(**) Term: **14 Years**

(21) Appl. No.: **29/366,121**

(22) Filed: **Jul. 20, 2010**

Related U.S. Application Data

(63) Continuation of application No. 29/352,321, filed on Dec. 18, 2009.

(51) **LOC (9) Cl.** **08-05**

(52) **U.S. Cl.** **D8/105**

(58) **Field of Classification Search** D8/99,
D8/58, 55, 52, 5, 356, 107, 105; D19/65;
81/440, 427.5; 7/160, 138, 128, 118; 30/298.4,
30/162, 161, 155

See application file for complete search history.

(56) **References Cited**

U.S. PATENT DOCUMENTS

4,744,272	A	5/1988	Leatherman	
4,776,094	A	10/1988	Glesser	
4,888,869	A	12/1989	Leatherman	
5,142,721	A	9/1992	Sessions et al.	
5,212,844	A *	5/1993	Sessions et al.	7/128
5,267,366	A	12/1993	Frazer	
D371,498	S *	7/1996	Lai	D8/105
5,564,318	A *	10/1996	Pail	81/427.5
5,628,117	A	5/1997	Glesser	
D382,182	S	8/1997	Seber et al.	
5,664,274	A *	9/1997	Collins	7/129

(Continued)

FOREIGN PATENT DOCUMENTS

EP 0 783 937 A2 7/1997

OTHER PUBLICATIONS

Serengeti Hunter, available at <http://www.crkt.com/serenget.html>, (Jul. 5, 2006), 2 pages.

(Continued)

Primary Examiner — Austin Murphy

(74) *Attorney, Agent, or Firm* — Alston & Bird LLP

(57) **CLAIM**

The ornamental design for a hand tool, as shown and described.

DESCRIPTION

FIG. 1 is a perspective view of another embodiment of a HAND TOOL according to our new design, shown in an open configuration;

FIG. 2 is a front elevation view thereof;

FIG. 3 is a rear elevation view thereof;

FIG. 4 is a left side elevation view thereof;

FIG. 5 is a right side elevation view thereof;

FIG. 6 is a top plan view thereof;

FIG. 7 is a bottom plan view thereto;

FIG. 8 is a perspective view thereof; shown in a close configuration;

FIG. 9 is a front elevation view thereof;

FIG. 10 is a rear elevation view thereof;

FIG. 11 is a left side elevation view thereof;

FIG. 12 is a right side elevation view thereof;

FIG. 13 is a top plan view thereof; and,

FIG. 14 is a bottom plan view thereto.

The broken lines immediately adjacent the shaded areas represent bounds of the claimed design and environment while all other broken lines are directed to environment and are for illustrative purposes only. The broken lines form no part of the claimed design.

1 Claim, 10 Drawing Sheets

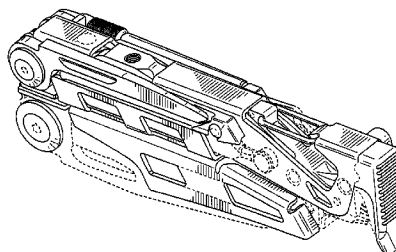
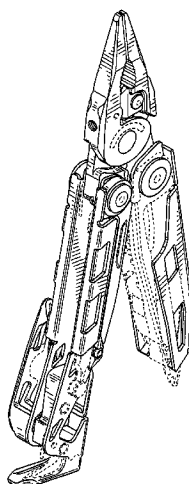

U.S. PATENT DOCUMENTS

5,689,886	A *	11/1997	Yeh	30/162
5,697,114	A	12/1997	McIntosh et al.	
D392,519	S *	3/1998	Hung	D8/5
5,745,997	A	5/1998	Berg et al.	
5,765,247	A	6/1998	Seber et al.	
5,781,950	A	7/1998	Swinden et al.	
5,791,002	A	8/1998	Gardiner et al.	
D401,133	S	11/1998	Gardiner et al.	
D405,676	S	2/1999	Rivera	
D406,030	S	2/1999	Gardiner et al.	
D406,508	S *	3/1999	Rivera	D8/52
D406,997	S	3/1999	Robbins	
D407,621	S	4/1999	Koon et al.	
D409,893	S	5/1999	Gardiner et al.	
D414,092	S *	9/1999	Chang	D8/55
D414,387	S *	9/1999	Hung	D8/5
5,963,999	A	10/1999	Gardiner et al.	
5,979,059	A	11/1999	Leatherman et al.	
6,003,180	A *	12/1999	Frazer	7/128
6,006,385	A	12/1999	Kershaw et al.	
6,009,582	A *	1/2000	Harrison et al.	7/118
6,014,787	A	1/2000	Rivera	
6,023,805	A	2/2000	Lin	
6,038,735	A	3/2000	Chang	
D426,446	S *	6/2000	Chau	D8/105
D426,447	S	6/2000	Chau	
6,223,374	B1 *	5/2001	Lin	7/127
D445,326	S *	7/2001	Alfaro	D8/107
6,276,063	B1	8/2001	Chen	
6,282,997	B1 *	9/2001	Frazer	81/427.5
6,289,768	B1 *	9/2001	Anderson et al.	81/3.09
6,293,018	B1 *	9/2001	Rivera	30/155
D448,636	S	10/2001	Yeh	
D455,629	S *	4/2002	Ping	D8/105
6,389,626	B1 *	5/2002	Hung	7/128
D469,328	S *	1/2003	Ping	D8/107
D470,372	S	2/2003	Rivera	
6,594,906	B1	7/2003	Sakai et al.	
D484,770	S	1/2004	Green	
6,694,558	B2	2/2004	Ping	
D505,057	S	5/2005	Ralph	
D509,125	S	9/2005	Ping	
7,000,323	B1	2/2006	Hatcher et al.	
7,028,591	B2 *	4/2006	Dallas et al.	81/300
7,051,627	B2 *	5/2006	Rivera	81/440
D529,789	S	10/2006	Klecker	
D538,138	S	3/2007	Knight	
D541,618	S *	5/2007	Klecker	D8/107
D557,100	S	12/2007	Stokes et al.	
7,347,128	B2 *	3/2008	Rivera et al.	81/450
7,353,736	B2 *	4/2008	Poehlmann	81/427.5
7,363,669	B2 *	4/2008	Berg et al.	7/128
D568,710	S	5/2008	Klecker et al.	
D569,212	S	5/2008	Hawk et al.	
D571,181	S	6/2008	Klecker et al.	
D573,009	S	7/2008	Nenadic	
D573,437	S	7/2008	Nenadic	
D573,865	S	7/2008	Klecker et al.	
7,406,896	B2 *	8/2008	Rivera	81/177.4
D592,931	S *	5/2009	Nenadic	D8/105
D596,911	S	7/2009	Carpenter et al.	
7,568,408	B2 *	8/2009	Tsuda	81/427.5
7,596,870	B2 *	10/2009	Klecker et al.	30/236
7,607,231	B2 *	10/2009	Klecker et al.	30/236
7,730,811	B2 *	6/2010	Robinson et al.	81/423
2001/0014986	A1 *	8/2001	Harrison	7/128

OTHER PUBLICATIONS

Deutsch, S., Preview: Leatherman Freestyle; available at <http://toolmonger.com/2008/02/18/preview-leatherman-freestyle/>, dated Jul. 18, 2008, 4 pages.
http://toolmonger.com/wp-content/uploads/2008/02/LM_Freestyle_Preview.jpg, dated Jul. 18, 2008, 1 page.
http://toolmonger.com/wp-content/uploads/2008/02/LM_Freestyle_Skeletooll.jpg, dated Jul. 18, 2008, 1 page.

Leatherman | Freestyle Tool With a Gift Tin | 830843 | B&H Photo, available at <http://www.bhphotovideo.com/c/product/511489-REG>, dated Jul. 18, 2008, 2 pages.
<http://www.bhphotovideo.com/images/largeimages/511489.jpg>, dated Jul. 18, 2008, 1 page.
http://www.bhphotovideo.com/images/multiple_images/item_images/IMG_7174.jpg, dated Jul. 18, 2008, 1 page.
 Johnson, J., Leatherman Freestyle: A Cheaper Skeletool, available at <http://gadgets.boingboing.net/2008/02/18/leatherman-freestyle.html>, dated Jul. 18, 2008, 3 pages.
 SHOT Show 2007 Report—Knives, available at http://www.equipped.org/shot_show_2007_knives4.htm; dated Jul. 18, 2008, 10 pages.
 Leatherman Freestyle Rendering, available at <http://www.equipped.org/pp/pic1902.htm>, dated Jul. 18, 2008, 1 pages.
 Leatherman Freestyle Bit Storage, available at <http://www.equipped.org/pp/pic1916.htm>, dated Jul. 18, 2008, 1 page.
 Leatherman Freestyle, available at <http://www.equipped.org/pp/pic1891.htm>, dated Jul. 18, 2008, 1 page.
 Leatherman Freestyle, available at <http://www.equipped.org/pp/pic1892.htm>, dated Jul. 18, 2008, 1 page.
 Leatherman Freestyle, available at <http://www.equipped.org/pp/pic1893.htm>, dated Jul. 18, 2008, 1 page.
 ESPN.com—Day two new products unveiled, available at <http://sports.espn.go.com/espn/print?id=2730032&type=story>, dated Jul. 18, 2008, 1 page.
 Leatherman Freestyle: Lighter Tools In Your Pocket—Homotron.net, available at http://www.homotron.net/2008/02/leatherman_freestyle_lighter_t.html, dated Jul. 18, 2008, 2 pages.
http://www.camping-gear-outlet.com/images/product/7_87718.jpg, dated Jul. 18, 2008, 1 page.
<http://raduborcea.files.wordpress.com/2008/05/skeletool-cx-diagram.jpg>, dated Jul. 18, 2008, 1 page.
<http://www.vikingchalet.com/~server/images/stories/skeletool-detail.jpg>, dated Jul. 18, 2008, 1 page.
http://toolmonger.com/wp-content/uploads/2007/09/TM_LeatherMan_Skeletool.jpg, dated Jul. 18, 2008, 1 page.
http://toolmonger.com/wp-content/uploads/2008/02/Skeletool_Beauty.jpg, dated Jul. 18, 2008, 1 page.
http://www.linux-mag.com/images/2007-12/gift-guide/Skeletool_CX_Beauty.jpg, dated Jul. 18, 2008, 1 page.
<http://www.gearcrave.com/wp-content/uploads/2007/11/skeletool.jpg>, dated Jul. 18, 2008, 1 page.
<http://knivesandmultitools.com/library/SkeletoolCX.JPG>, dated Jul. 18, 2008, 1 page.
 U.S. Appl. No. 29/346,851, filed Nov. 6, 2009; In re: Steineckert et al., entitled “Hand Tool”.
 U.S. Appl. No. 29/346,849, filed Nov. 6, 2009; In re: Steineckert et al., entitled “Hand Tool”.
 U.S. Appl. No. 29/335,352, filed Apr. 14, 2009; In re: Castro, entitled “Wire Cutter”.
 The Pocket Toolbox™, G10 MaxGrip, Multitasker Ultralight, Multitasker Tools LLC, Brochure, 2 pages.
 Multi Tools 14-in-1 Hammer Tool [online] [retrieved Jan. 25, 2010]. Retrieved from the internet: <URL: [http://greatnecksaw.com/product_info.php?pName=14in1-hammer-tool&cName=all-purpo...>. 2 pages.
 eFECT™, SpecialityTools, 2010 Gerber Military Product Catalog, Jun. 1, 2009, p. 16.
 Multitasker Tool \[online\] \[retrieved Apr. 16, 2010\]. Retrieved from the internet: <URL: \[http://www.multitaskertools.com/images/2009tool.jpg...>. 1 page.
 Gerber Knife \\[online\\] \\[retrieved Apr. 16, 2010\\]. Retrieved from the internet: <URL:<http://images.knifecenter.com/knifecenter/gerber/images/GB000030.jpg>> 1 page.
 Leatherman Charge TTI, Internet; accessed online Jun. 28, 2010; \\[http://images.shopleatherman.com/Lg/5366_1/830682_Leatherman_Charge_TTI_w_Leather_Sheath.jpg\\]\\(http://images.shopleatherman.com/Lg/5366_1/830682_Leatherman_Charge_TTI_w_Leather_Sheath.jpg\\).\]\(http://www.multitaskertools.com/images/2009tool.jpg...\)](http://greatnecksaw.com/product_info.php?pName=14in1-hammer-tool&cName=all-purpo...)

* cited by examiner

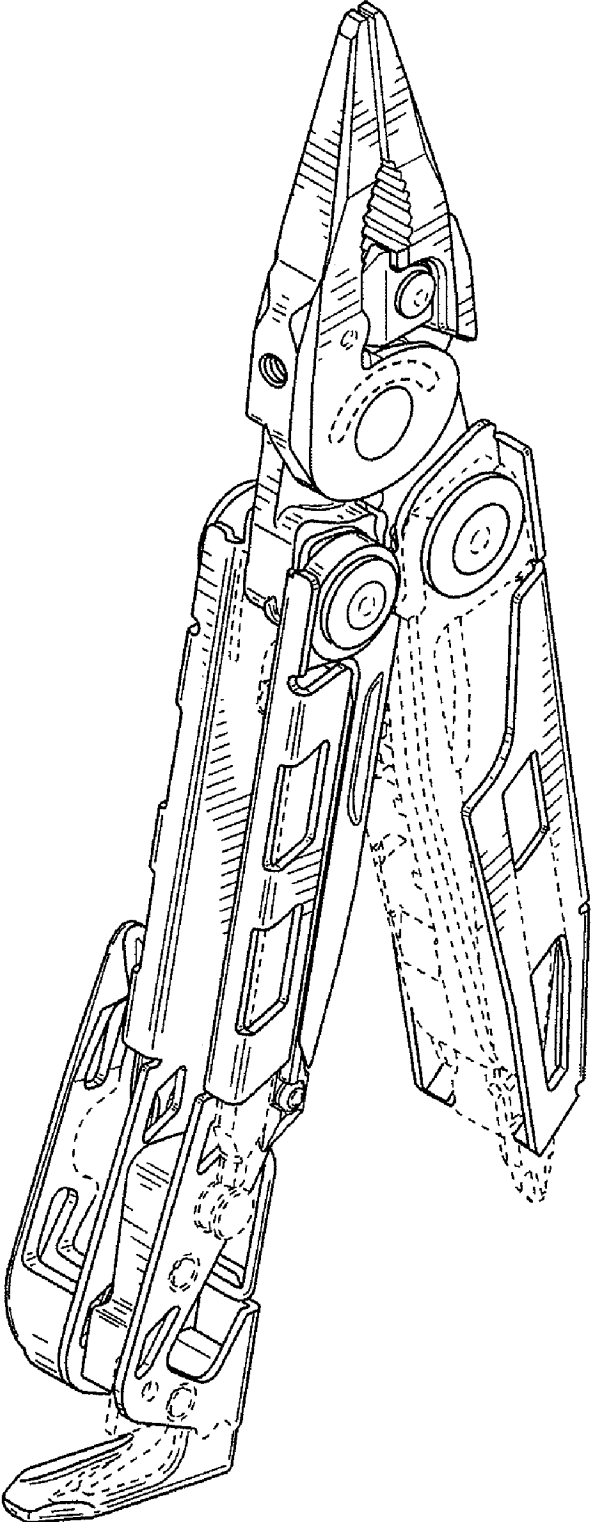

FIG. 1

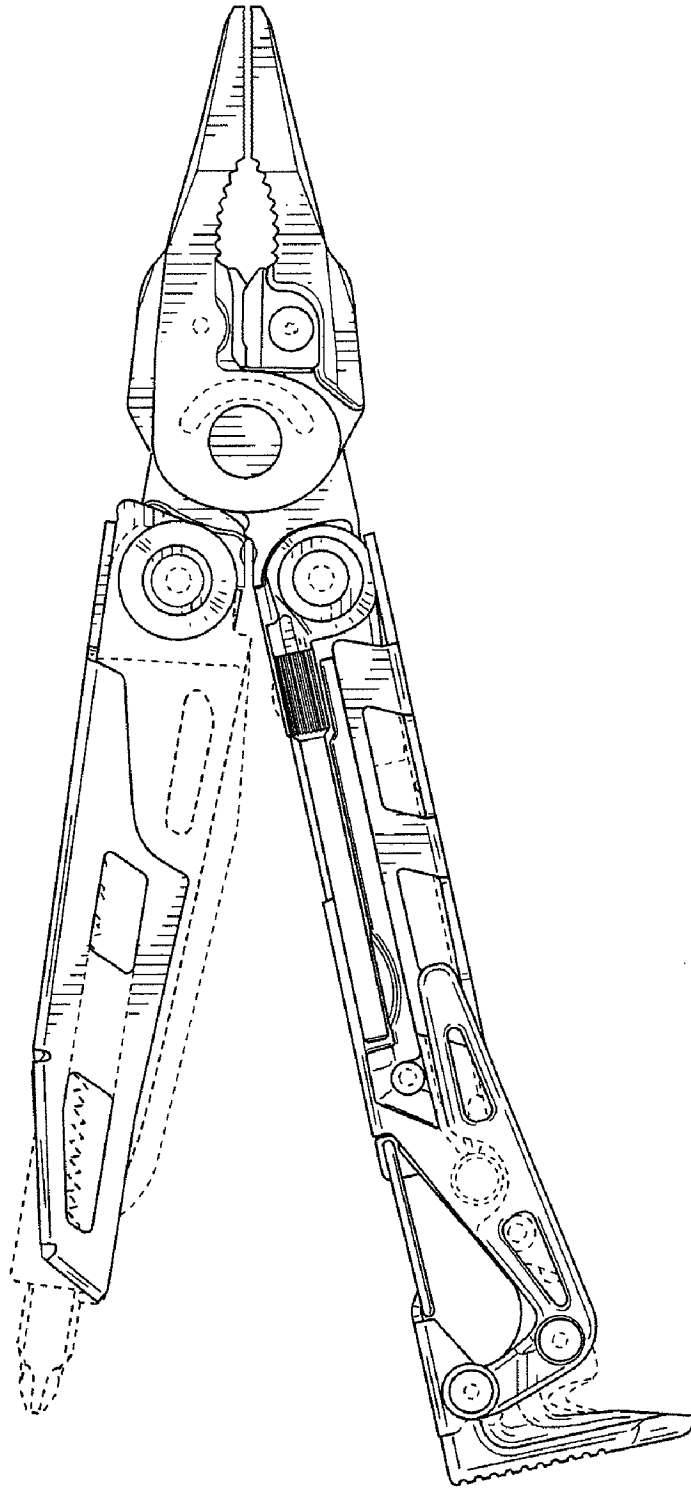

FIG. 2

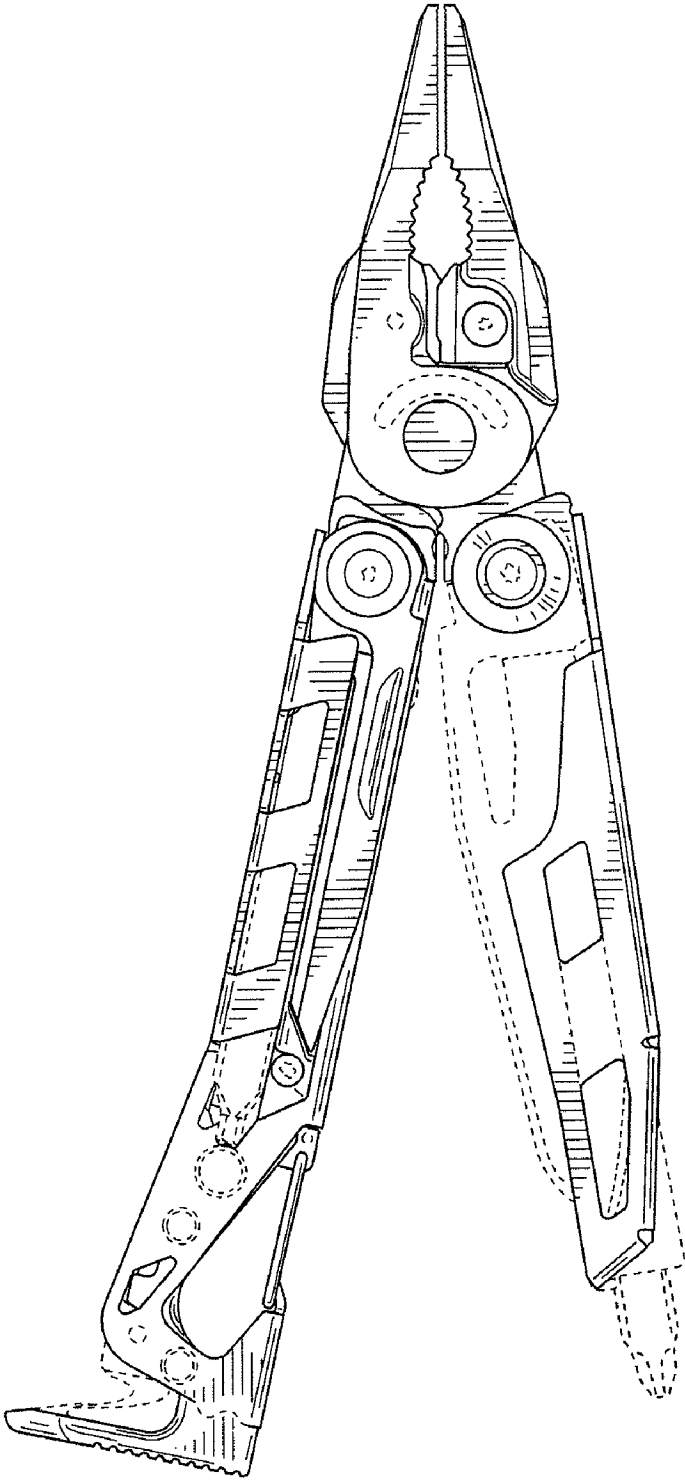

FIG. 3

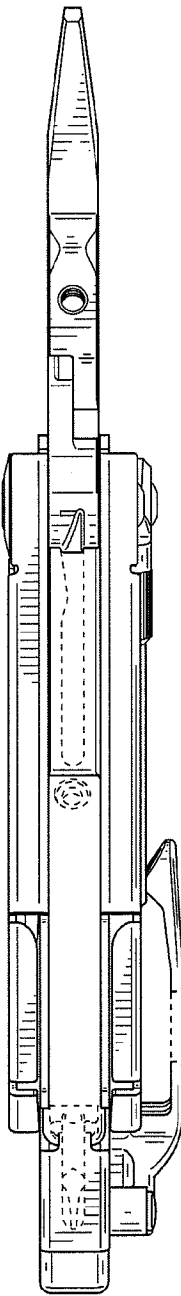

FIG. 4

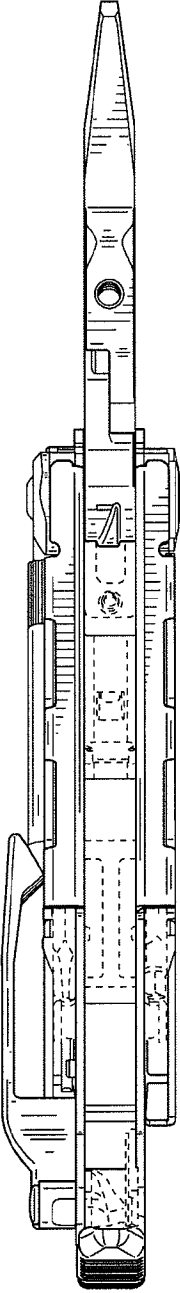

FIG. 5

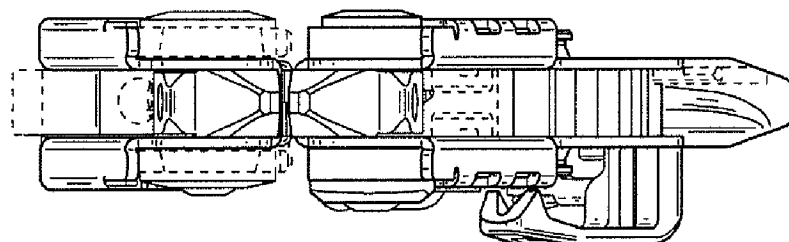

FIG. 6

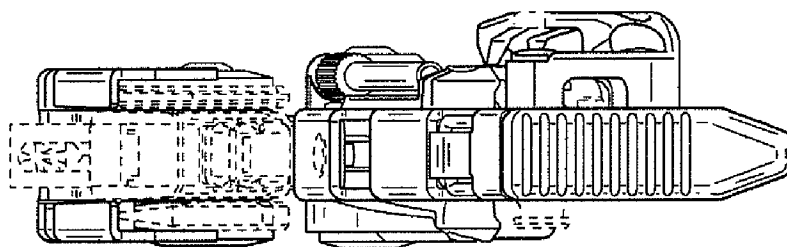

FIG. 7

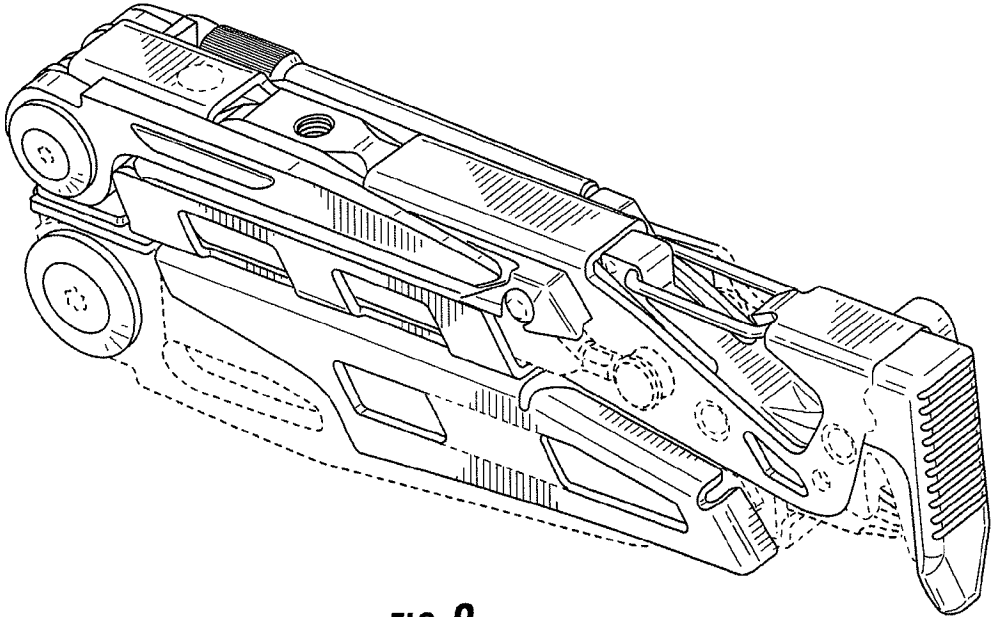

FIG. 8

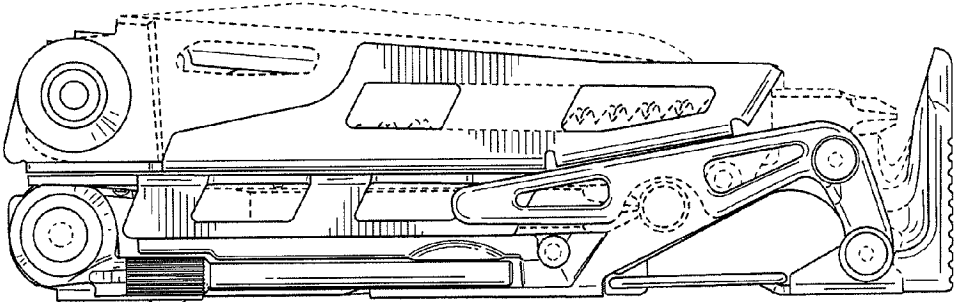

FIG. 9

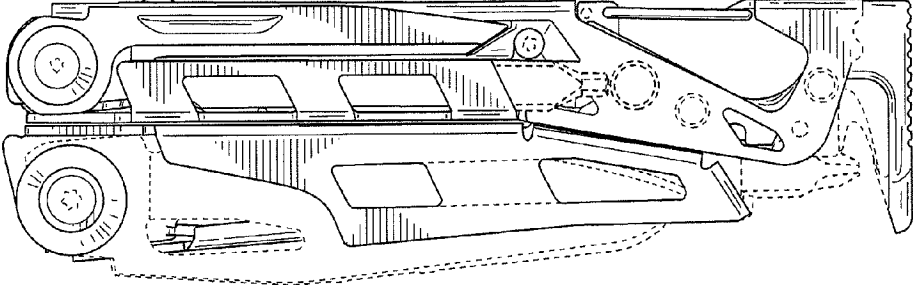

FIG. 10

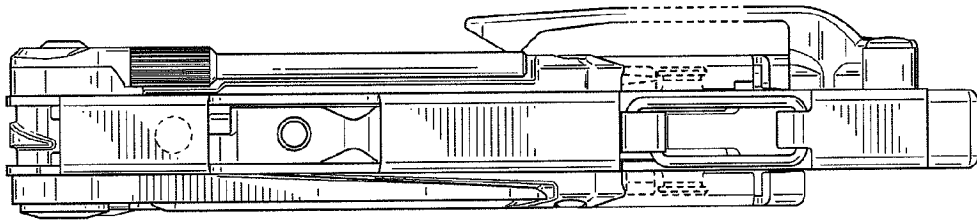

FIG. 11

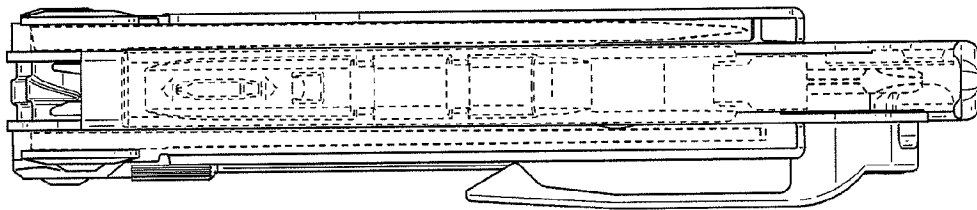

FIG. 12

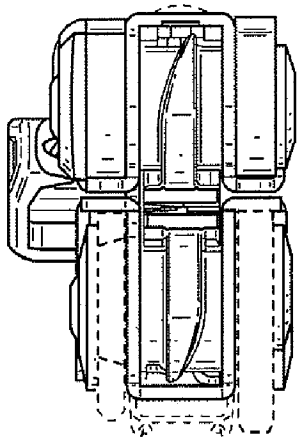

FIG. 13

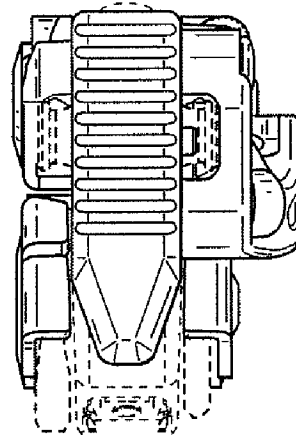

FIG. 14