

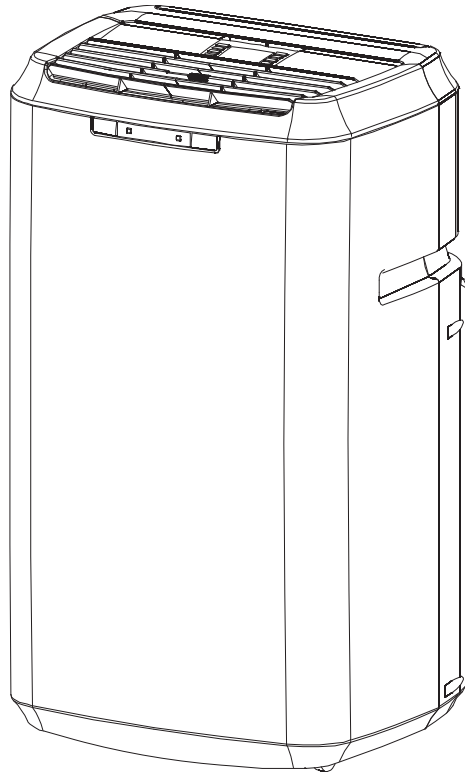

Portable Air Conditioner



AP12005ECO

Owner's Manual

For more information on other great EdgeStar products on the web, go to <http://www.edgestar.com>

Important Safety Information

Improper handling can cause serious damage to the appliance and/or to the user.

This portable air conditioner is not intended for use by children. Children should be supervised to ensure that they do not play with this product.

Electrical Safety

- This unit is designed for indoor use only.
- Do not use the unit in extremely humid or wet environments.
- Do not wet the housing or control panel.
- Do not pull the unit by the cord.
- Always turn the unit off and unplug it from the socket when cleaning.
- Unplug the unit if it is not going to be used for a long period of time.
- Do not operate the unit with a damaged plug or a loose socket.
- Use only the correct power supply with appropriate amperage.
- If the power cord is damaged, it must be replaced by the manufacturer, a service agent, or qualified technician.
- Do not remove any part of the casing unless instructed by an authorized technician.

General Safety

- This portable air conditioner is not intended to be used by children.
- Do not allow children to play with the controls or drop any objects into the air outlets or vents.
- Do not place objects or let any person sit on top of the unit.
- Only use in the upright position on a flat, level surface and provide at least 20 inches of clearance from any walls or objects.
- Route the power cord carefully to avoid a tripping hazard.
- This unit is intended for domestic use only. Do not use the portable air conditioner for industrial or commercial use. Any other use may invalidate the warranty.

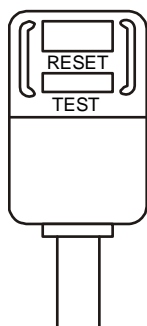

Your portable air conditioner is supplied with a Leakage-Current Detection and Interruption (LCDI) safety plug. This device provides protection to reduce the risk of fire due to arcing faults in the power supply cord. Before using your portable air conditioner, follow the instructions below to ensure that the LCDI plug is working properly:

1. Plug the power cord to a grounded outlet.
2. Press the TEST button on the LCDI plug. This should trip the plug and cut the power to the air conditioner. If the plug does not trip and you are able to turn on the unit, please contact EdgeStar support.

DO NOT USE YOUR PORTABLE AIR CONDITIONER IF THE TEST FAILS.

Press the RESET button to start using your air conditioner.

Do not use the TEST and RESET buttons as an ON/OFF switch.

Table of Contents

IMPORTANT SAFETY INFORMATION	I
TABLE OF CONTENTS	II
INTRODUCTION	1
PARTS IDENTIFICATION	2
BACK VIEW	2
FRONT VIEW	2
INSTALLING THE CARBON FILTER	3
WINDOW KIT INSTALLATION INSTRUCTIONS	4
PREPARATIONS FOR INSTALLING THE WINDOW KIT	4
INSTALLING THE GRATED ADAPTER	5
INSTALLING THE WINDOW PLATES	6
ATTACHING THE DUCT CONNECTORS TO THE EXHAUST HOSE	7
CONNECTING THE DUCT CONNECTOR TO THE UNIT	8
CONNECTING THE DUCT CONNECTOR TO THE GRATED ADAPTER	8
REMOTE CONTROL OVERVIEW	9
INSTALLING THE BATTERIES	9
REMOTE CONTROL LCD INDICATORS	10
OPERATING THE REMOTE CONTROL	11
POWER	11
AUTO-RESTART:	11
COOLING MODE	11
DEHUMIDIFYING MODE	11
FAN ONLY MODE	12
AUTOMATIC MODE	12
FAN SPEED	12
CLOCK	12
TIMER	13
<i>How to set the unit to automatically turn on</i>	13
<i>How to set the unit to automatically turn off</i>	13
FRONT PANEL LIGHTS AND CONTROLS	13
FRONT PANEL LIGHTS	13
FRONT PANEL CONTROLS	13
ENERGY SAVING GUIDE	14
MAINTENANCE	15
CLEANING THE UNIT	15
CLEANING THE PRE-FILTER	15
PREPARATION FOR STORAGE	15
TROUBLESHOOTING	16
TROUBLESHOOTING CONTINUED	17
SPECIFICATIONS	18
EDGE STAR LIMITED WARRANTY	19

Introduction

Thank you for purchasing this EdgeStar portable air conditioner. We are glad you chose us. We believe that your purchase of this product opens a relationship between you and EdgeStar. We will provide the customer support needed to nurture that relationship.

This manual contains important information regarding the proper installation, use and maintenance of your portable air conditioner. Following this manual will ensure that your product will work at its peak performance and efficiency.

Please save the original product packaging in case you need to safely transport your portable air conditioner.

For Your Records:

Please write down the model number and serial number below for future reference. Both numbers are located on the ratings label on the back of your unit and are needed to obtain warranty service. You may also want to staple your receipt to this manual as it is the proof of your purchase, and is also needed for service under your warranty.

Model Number: _____

Serial Number: _____

Date of Purchase: _____

To better serve you, please do the following before contacting customer service:

- If you received a damaged product, immediately contact the dealer that sold you the product.
- Read and follow this instruction manual carefully to help you install, use and maintain your portable air conditioner.
- Read the troubleshooting section of this manual as it will help you diagnose and solve common issues.
- Visit us on the web at <http://www.edgestar.com> for product guides, additional troubleshooting resources and up-to-date information. If you need service, our friendly customer service representatives are available via email at service@edgestar.com or by telephone at **1 (866) 319-5473**.

Parts Identification

Front View

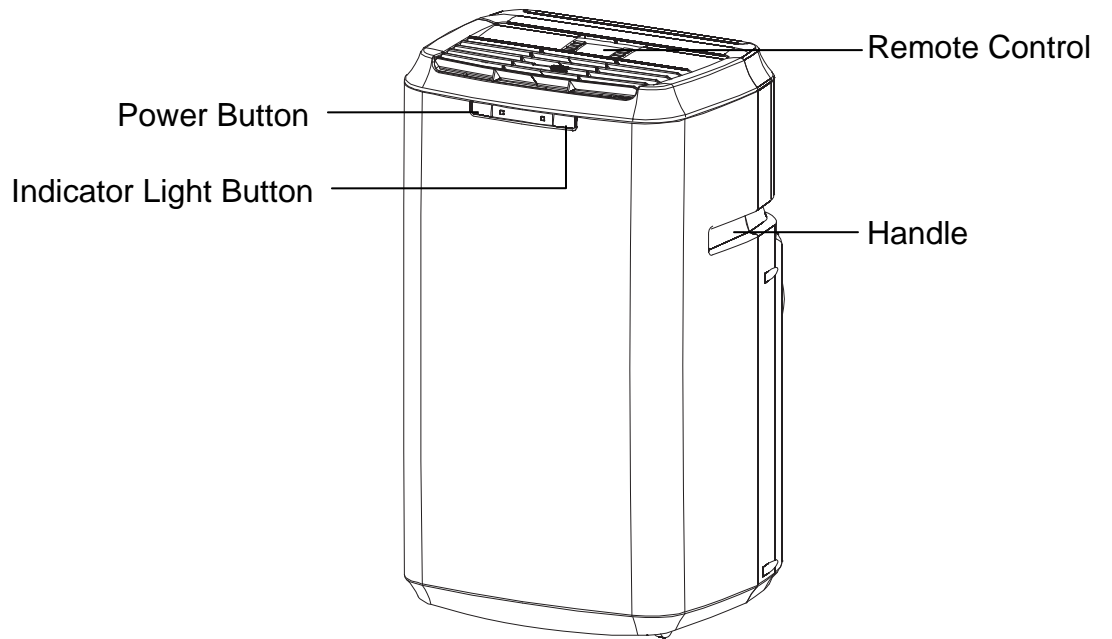

Back View

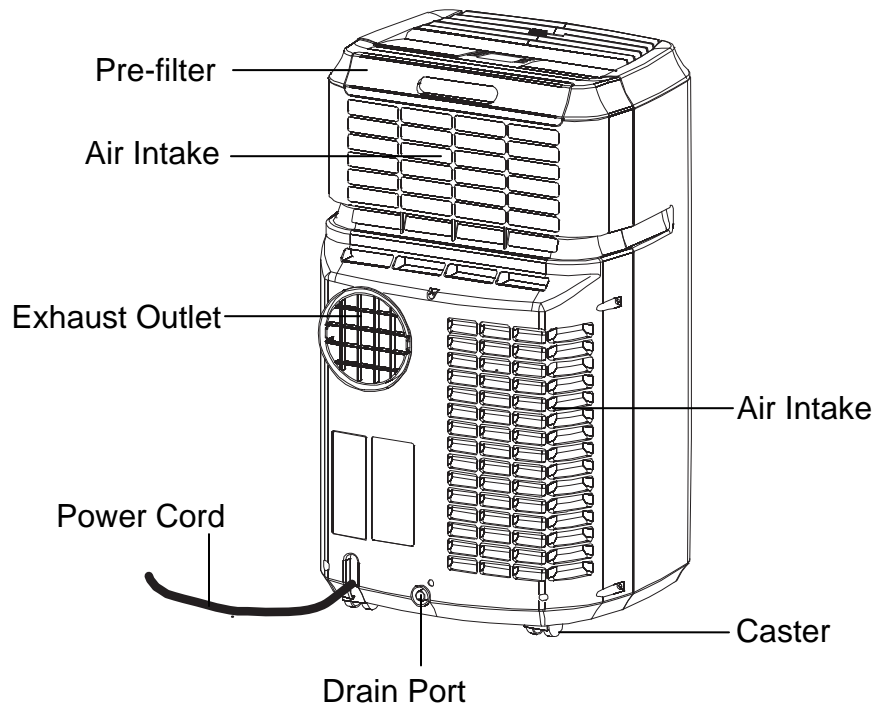

Installing the Carbon Filter

Your portable air conditioner ships with a pre-filter and an activated carbon filter. The carbon filter will help remove contaminants and odors from the air. It is recommended you replace the carbon filter every two to three months, or as needed. It is necessary to clean the pre-filter periodically. Follow the steps below to install the carbon filter:

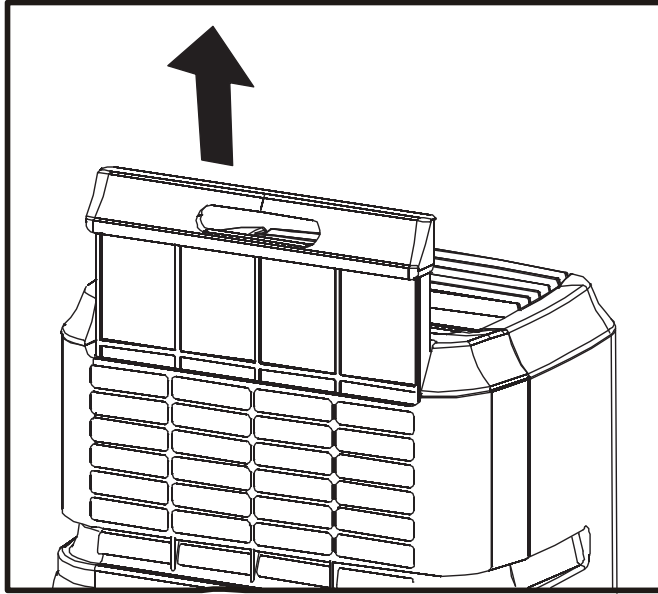

CAUTION: Never operate the air conditioner without the pre-filter attached.

1. Pull the handle on the pre-filter straight up.

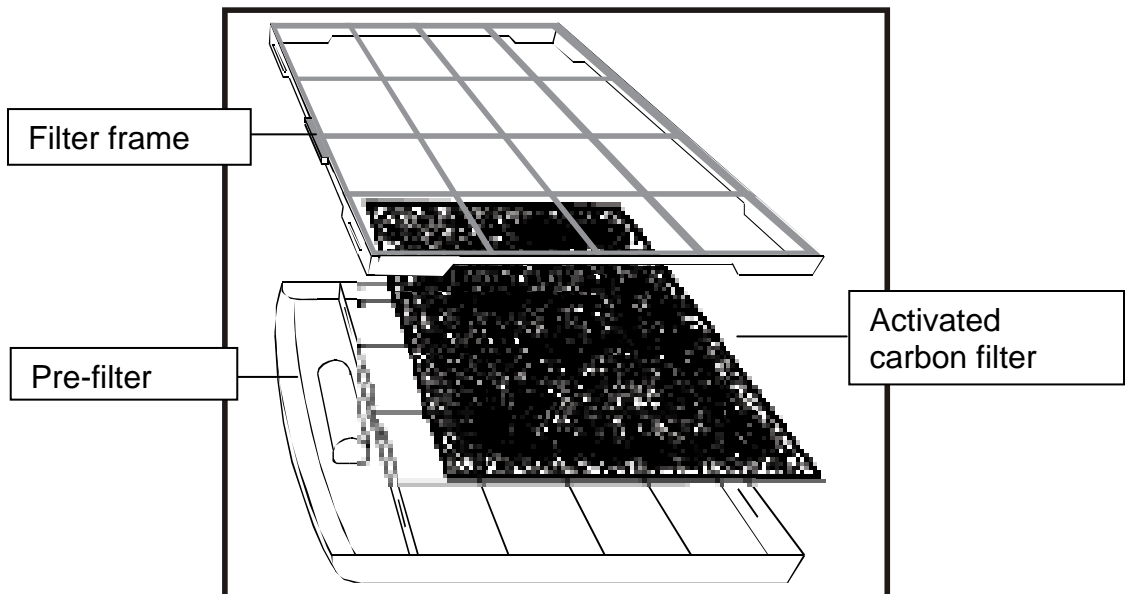

2. Separate the filter frame from the pre-filter.
3. Place the activated carbon filter on the pre-filter.
4. Reattach the filter frame.
5. Insert the assembled pre-filter into the back of the unit

Window Kit Installation Instructions

Preparations for installing the window kit

You must vent your portable air conditioner when running in it cooling mode. Your unit includes a window exhaust kit that can be used to vent the unit out a window.

Before you begin, make sure you have all the parts necessary for installation.

Window Kit Parts List:

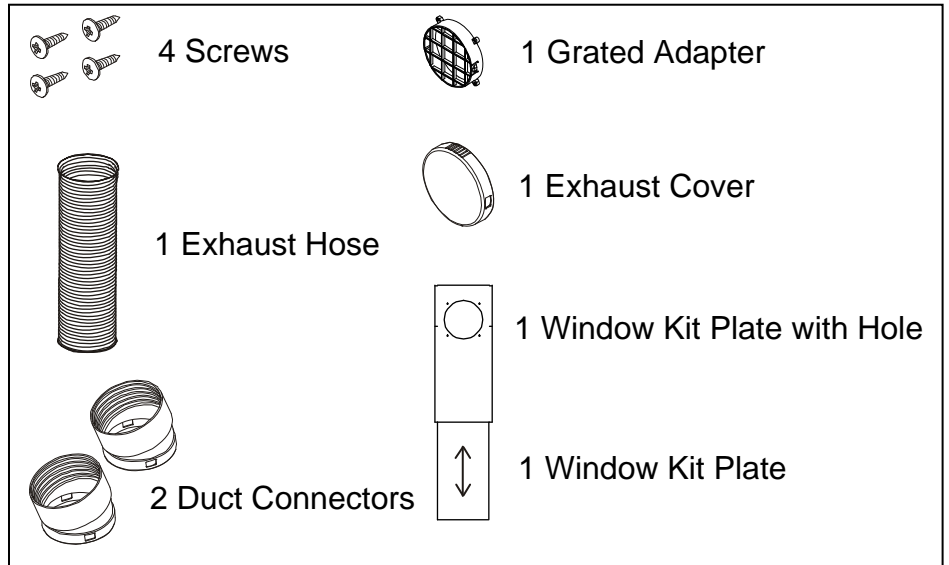

NOTE: You may need to contact your electrician if your room's circuit is not able to power your unit.

If you have multiple windows, choose one that is near an electrical outlet that will be able to provide sufficient power to your unit. See the power requirements listed on the product label printed on the side, or on the back of your portable air conditioner.

Your window kit can be installed on a horizontal or vertical sliding window as shown in the following pictures:

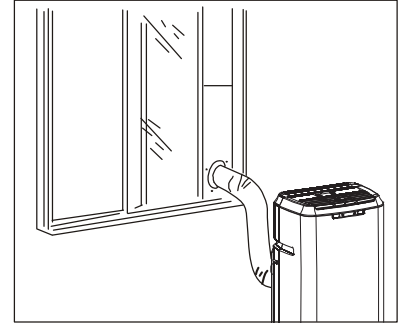
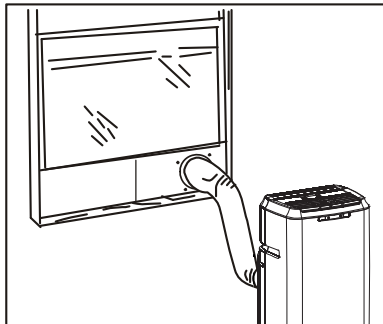

Follow the instructions on the next pages to install the window kit.

Installing the grated adapter

①

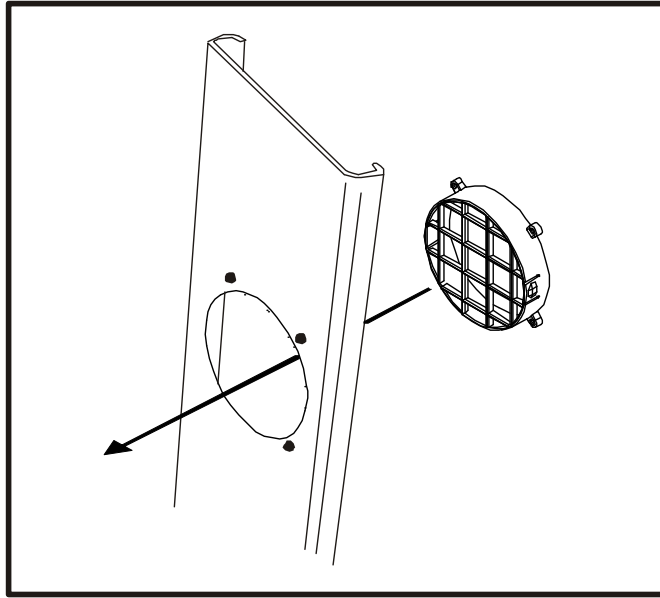

1. Insert the round grated adapter through the back grooved side of the window kit plate with hole.

②

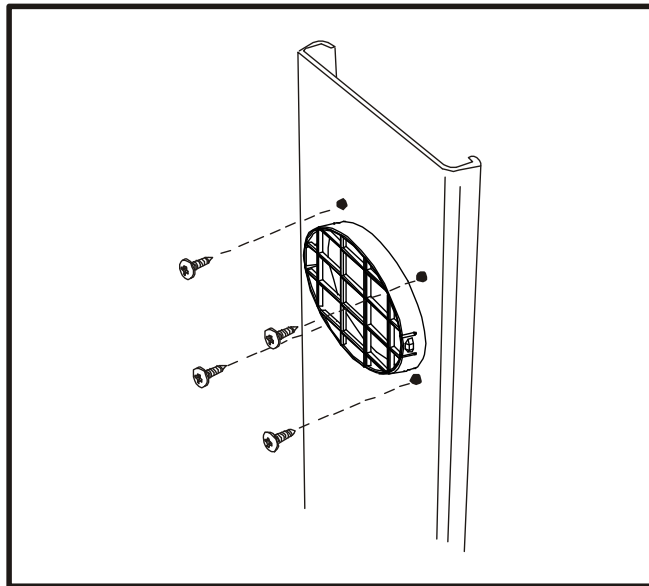

2. Secure the grated adapter by fastening the screws from flat side of the window kit plate to the holes on the grated adapter.

Installing the window plates

③

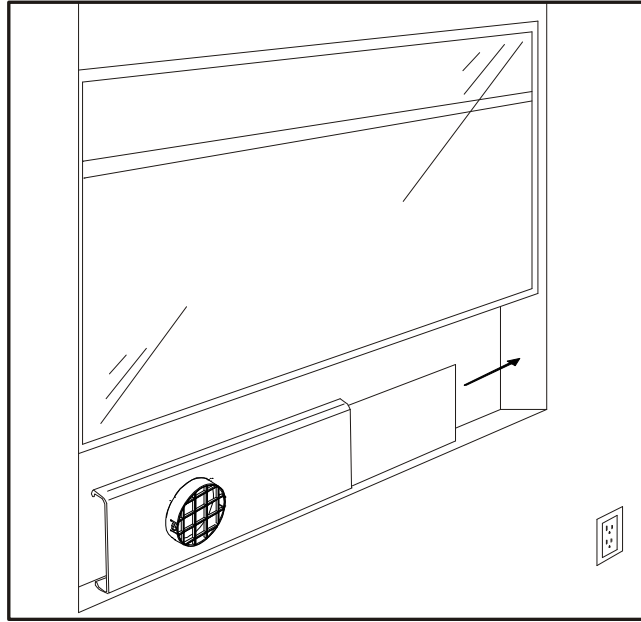

3. Open your window and place the window kit with grooved side facing outward on the window sill. Then, slide the window kit plate to fit the width of the window. You can use screws to secure the window kit plate from sliding.

④

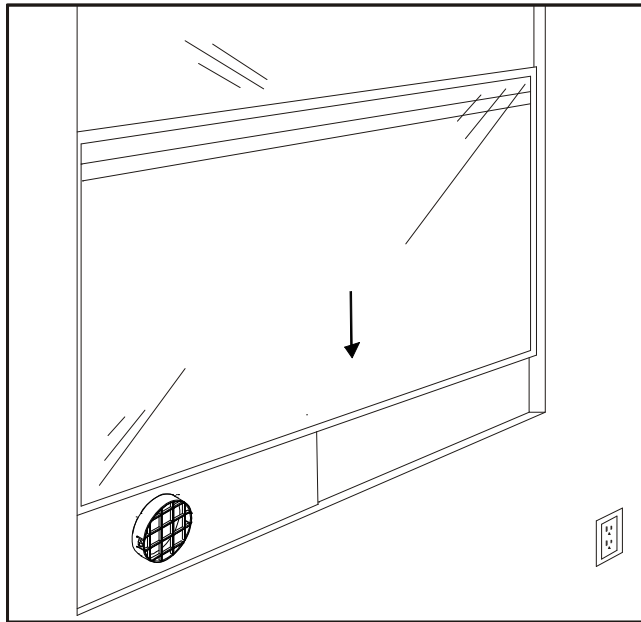

4. Lower the window to secure the window kit in place. You may need to use duct tape to better secure the window kit.

CAUTION: Secure your window by using window locks. Please contact your EdgeStar retailer to purchase window locks.

**Attaching the duct
connectors to the exhaust
hose**

⑤

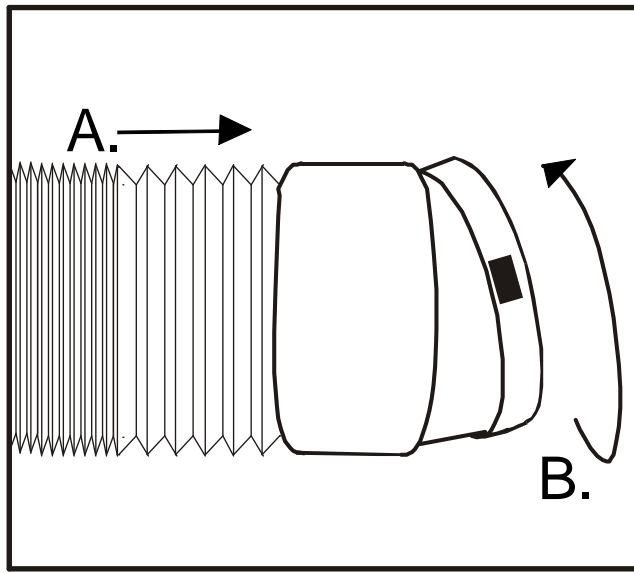

5. Attach the connectors to the hose:
A. Extend the ends of the exhaust hose
B. Thread the duct connector on by turning it clockwise until it stops.

⑥

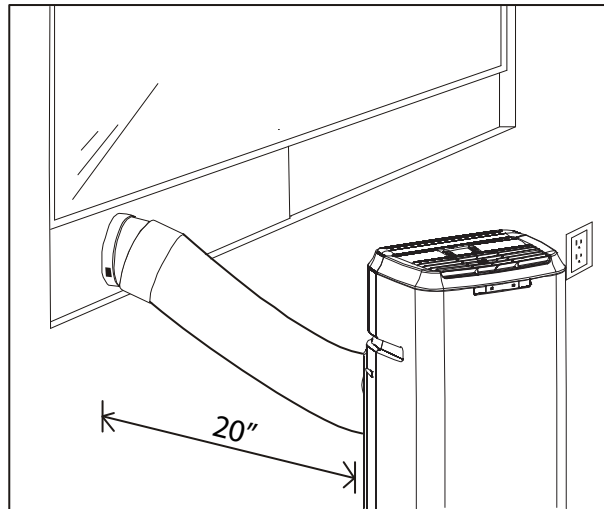

6. Roll the unit towards the window kit. Leave a space that is at least 20 inches to the wall.

Connecting the duct connector to the unit

7

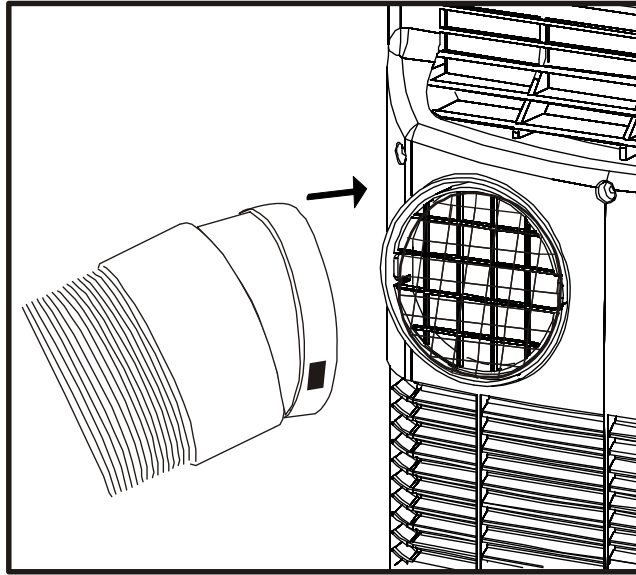

7. Align the slots on the duct connector to the tabs and snap into the back of the unit.

Connecting the duct connector to the grated adapter

8

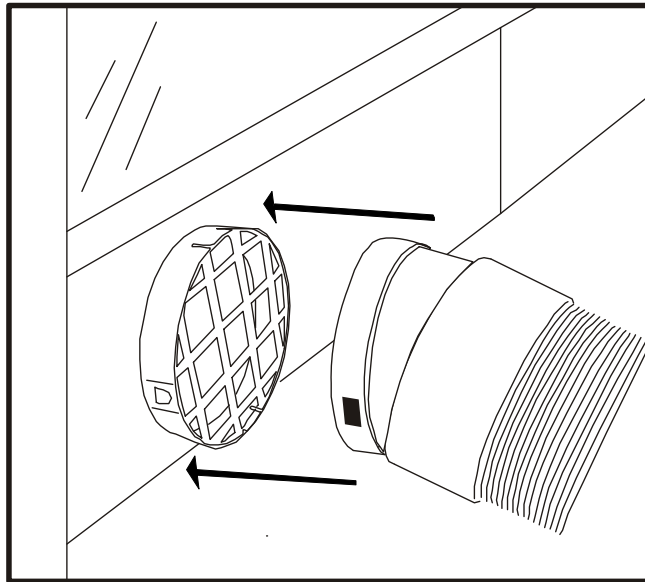







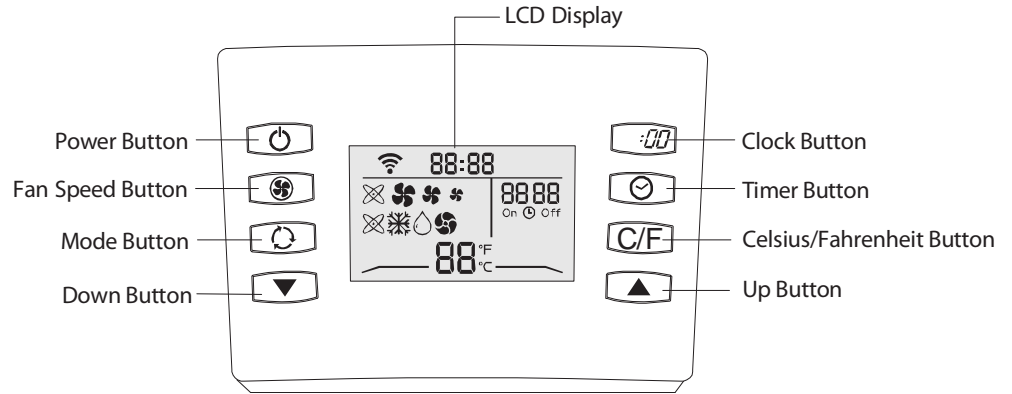









8. Align the slots on the duct connector to the tabs on the grated adapter and snap in place.

After you have installed the exhaust hose and window kit, you can plug in your portable air conditioner and start using it.

Remote Control Overview



Button	Function
 Power	Powers the unit on or off.
 Fan Speed	Sets the fan speed. The  Automatic,  High,  Medium or  Low indicator will appear depending on the mode you set.
 Mode	Sets the mode. The  Automatic,  Cool,  Dehumidify and  Fan indicator will appear depending on the mode you set.
 (Down)	Decreases the Temperature, Timer, or Clock settings.
 (Clock)	Used to set the remote control clock
 Timer	Used to enable the timer.
 C/F	Switches the temperature between Celsius/Fahrenheit
 (Up)	Increases the Temperature Timer, or Clock settings.

Installing the batteries

- 1) Remove the cover on the back of the remote control.
- 2) Insert the batteries with the (+) and (-) ends pointing in the correct direction.
- 3) Slide the cover back on.

CAUTION: Use only AAA batteries. Remove the batteries if the remote control will not be used for one month or longer. Do not attempt to recharge batteries not designed to be recharged. All batteries should be replaced at the same time. Do not mix old and new batteries. Do not dispose of batteries in a fire as they may explode.

Remote Control LCD Indicators

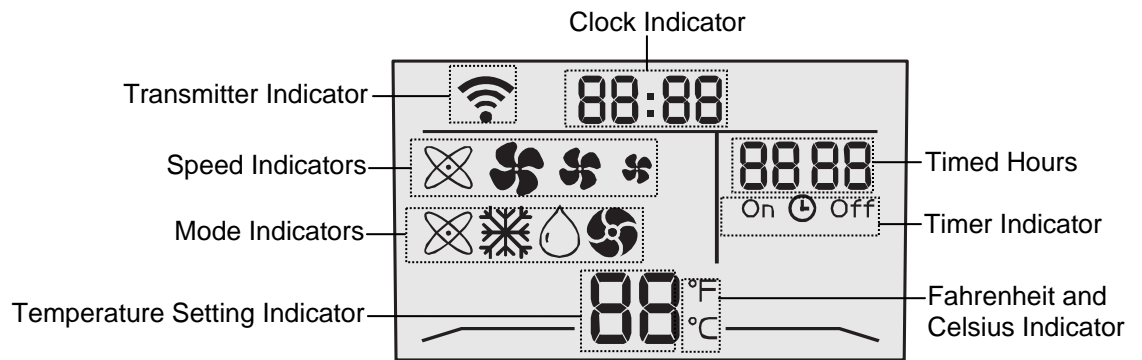

Indicators	
Transmitter	Appears when the Power or Timer button is signaling the unit.
Fan Speed	Shows the set fan speed between Automatic, High, Medium and Low.
Mode	Shows the set mode between Automatic, Cooling, Dehumidify, Fan Only.
Temperature Setting	Shows the set temperature.
Fahrenheit and Celsius	Shows if the set temperature is in Fahrenheit or Celsius.
Clock	Shows the Clock's time. The remote control has a 24-Hour clock.
Timed Hours	Shows the number of timed hours when the Timer is enabled.
Timer	Shows if the On Timer or Off Timer is enabled.

Mode Indicator	Function
Automatic	The unit will cool, dehumidify or heat (some models) depending on the ambient temperature. The mode and fan speed changes automatically. The front panel lights will change to reflect the running mode.
Cooling	The unit will cool. The front panel lights will be blue.
Dehumidify	The unit will remove moisture from the air. The front panel lights will be yellow.
Fan Only	The unit will run as a fan and circulate air. The front panel lights will be green.

Operating the Remote Control

Power

Use the  Power button to turn the portable air conditioner on and off.

By default when you first use the power button, the unit will begin to operate in cooling mode and the front panel will be illuminated in blue. The unit will remember the last used mode/settings if you shut down and restart.







Auto-Restart: If power to the unit is interrupted, the air conditioner will restart itself in its last used mode/settings once power is restored. The compressor will restart after 3 minutes.

Cooling Mode

Cooling mode cools and dehumidifies the air. If the ambient temperature drops below the temperature you selected, the compressor turns off and the unit functions with the fan only. When the temperature rises above the temperature you selected, the compressor turns on again. The front panel lights will be blue.

Whether your desired temperature can actually be reached depends on the ambient conditions. The room temperature remaining above the set temperature is normal.

To operate the unit in cooling mode:



- 1) Make sure the power cord is plugged into a power outlet.
- 2) Press the  Power button on the remote control.
- 3) Press the  Mode button until the  cooling indicator is selected.
- 4) Select the fan speed by using the  Speed button.
- 5) Set the thermostat by using the  Up and  Down buttons. The thermostat is adjustable between 64°F - 90°F in one degree increments. You can switch between Fahrenheit and Celsius by pressing the  button.

NOTE: The exhaust hose must be used in Cooling mode in order to cool a room.

Dehumidifying Mode

During the Dehumidifying mode, the unit will condense water out of the air and exhaust it through the exhaust hose. The ambient temperature in the room will probably drop by a few degrees while using the Dehumidifying mode. The front panel lights will be yellow.

To operate the unit in dehumidifying mode:









- 1) Make sure the power cord is plugged into a power outlet.
- 2) Press the  Power button on the remote control.
- 3) Press the  Mode button until the  dehumidify indicator is selected.

NOTES: If the room temperature is below 77°F, the fan will always run on low speed while in the Dehumidifying mode. If you do not use the exhaust hose in Dehumidifying mode, you must manually drain the water from the unit. Additionally, the ambient temperature in the room will probably rise by a few degrees if you do not use the exhaust hose. You will not be able to change the thermostat temperature while in Dehumidifying Mode.

Fan Only Mode

Fan Only mode is used to circulate the air in your room. No temperature setting is needed. The front panel lights will be green.

To operate the unit in Fan Only mode:



- 1) Make sure the power cord is plugged into a power outlet.
- 2) Press the  Power button on the remote control.
- 3) Press the  Mode button until the  Fan Only indicator is selected.
- 4) Press the  Speed button to select the fan speed. You can choose between  Automatic,  High,  Medium and  Low.

NOTE: Fan Only mode does not require that the exhaust hose be attached.

Automatic Mode





In Automatic mode, the unit will cool, dehumidify, or heat (some models) depending on the ambient temperature. As the temperature in the room changes, the mode and fan speed will change automatically. The front panel lights will change depending on the mode.

To operate the unit in Automatic mode:

- 1) Make sure the power cord is plugged into a power outlet.
- 2) Press the  Power button on the remote control.
- 3) Press the  Mode button until the  Automatic indicator is selected.

Fan Speed

The  Fan Speed button is used to change the fan speed while in Cooling and Fan Only modes.

Press the  Fan Speed button to select the fan speed. The  Automatic,  High,  Medium or  Low indicator can be selected.

Note: You will not be able to change the fan speed if the unit is in Automatic or Dehumidify mode.





Clock

The  Clock button is used to set the Clock.

TIP: Use the Chart below:

12-Hour	24-Hour
1:00 PM	13:00
2:00 PM	14:00
3:00 PM	15:00
4:00 PM	16:00
5:00 PM	17:00
6:00 PM	18:00
7:00 PM	19:00
8:00 PM	20:00
9:00 PM	21:00
10:00 PM	22:00
11:00 PM	23:00
12:00 AM	00:00





To set the Clock:

- 1) Press and hold the  Clock button until the Clock indicator starts blinking.
- 2) Set the time by using the  Up and  Down buttons. Holding down the buttons longer than 1 second will change the time in fast mode. The clock is a 24-Hour clock so if it is 6:00 PM you would set the time to be 18:00.
- 3) To save your settings press and hold the  Clock button until the Clock indicator stops blinking.





Timer

The timer can be used to either turn the unit on or off after a number of elapsed hours. The timer is adjustable between 1-24 hours in one hour increments.

How to set the unit to automatically turn on:

- 1) Press the  Timer button while the unit and remote are powered off. The On Timer [On ] indicator will be selected and the timed hour indicator will be blinking.
- 2) Use the  Up and  Down buttons to set the number of hours you want to pass before the unit turns on.
- 3) Press the  Timer button again to set the timer. The timed hour indicator will stop blinking. After the selected time passes, the unit will automatically turn on.

How to set the unit to automatically turn off:

- 1) Press the  Timer button while the unit and remote are powered on. The Off Timer [ Off] indicator will be selected and the timed hour indicator will be blinking.
- 2) Use the  Up and  Down buttons to set the number of hours.
- 3) Press the  Timer button again to set the timer. The timed hour indicator will stop blinking. The unit will automatically turn off after the selected time elapses.

NOTE: To cancel the timer, press  Power button or set it at "00".

Front Panel Lights and Controls

Front Panel Lights

Your portable air conditioner has a front panel that lights up different colors depending on the mode it is running.

Cooling mode will display a blue light.

Dehumidify mode will display a yellow light.

Fan mode will display a green light.

Heating mode (on some models) will display a red light.

Automatic mode will display the color of the current mode.

If the unit flashes a red light and the unit stops cooling, this indicates that the internal water reservoir is full. Place a pan under the unit, and remove the drain plug to drain the unit.

If the lights flash from left to right and the unit does not work, contact customer service.

Front Panel Controls

 The front panel has an emergency power switch. The power switch can be used when the unit needs to be shut off or turned on without the remote control.



You can turn off the front panel lights by hitting the Lamp Off switch.

Energy Saving Guide

Read and follow the guide below to get the best performance and efficiency from your portable air conditioner:

- Do not cover the air outlet (exhaust) while in use.
- Do not place the unit in front of curtains or drapes- to ensure they do not obstruct the air intake.
- Minimize the length of the exhaust hose.
- Make sure the exhaust hose is as straight as possible and avoid kinks or bends.
- Keep curtains, blinds or drapes closed during the sunniest part of the day.
- Use the timer to operate the unit before it is needed. For example, set the timer to turn on the unit in cooling mode for 3 or more hours to cool the room before you arrive. You may want to operate the unit all day if you live in a warmer climate.
- Minimize the heat sources (direct sunlight, computers, servers, people, etc.) in the room.
- Close all windows and doors.
- Use the unit in a contained room. For example, a room with four walls and a ceiling, instead of a partitioned studio, or warehouse.
- Make sure the unit is on a level surface.
- Minimize the amount of humidity in the room. For example, run the unit as a dehumidifier.
- To prolong the compressor's life, please wait at least 3 minutes before turning the unit back on after shutting it off.
- Inspect and keep the pre-filters clean by cleaning regularly.
- Inspect and replace the activated carbon filters regularly.
- Perform routine maintenance.

Maintenance

Clean the air conditioner and filters regularly to maximize performance and efficiency, and prolong the unit's life. Be sure to always unplug the air conditioner from the power outlet before cleaning.

Cleaning the unit

Use a soft dry cloth to wipe the body clean. If necessary, use lukewarm water to dampen a cloth to clean the unit. Use a soft bristle brush to clean between the vents. Carefully use a vacuum cleaner to clean the condenser coils

Never use abrasive chemicals, volatile substances, gasoline, detergents, chemically treated cloths, or other cleaning solvents that may damage the cabinet exterior.

Never spray water directly on the unit.

Cleaning the pre-filter

To clean the pre-filter, follow the steps below:

- 1) Power off the unit and remove the pre-filter.
- 2) Remove the activated carbon filter.
- 3) Use a vacuum cleaner or tap the filter lightly to remove loose dust and dirt, then rinse thoroughly under lukewarm running water (below 104°F). You may use a mild soap and water solution if needed. Allow the pre-filter to air dry in a cool and shaded place. Dry thoroughly before reinstalling.

NOTE: The activated carbon filter is not washable. You should replace it every 2-3 months or as needed. Contact EdgeStar retailers for replacement filters.

Clean the pre-filter periodically. If the unit is used in a dusty environment you may need to clean it on a weekly basis.

Warning: Never operate the unit without the filters.

Preparation for Storage

If you are not going to be using the unit for an extended period of time, follow the instructions below before storing your unit:

- 1) Drain all the water from the unit's reservoir. Operate the unit in fan mode for a few hours to thoroughly dry any moisture left on the coils inside the unit.
- 2) Power off the unit, and clean or change the filters.
- 3) Unplug and carefully wind the power cord.
- 4) Remove the exhaust hose and duct connectors and keep them in a safe place.

Troubleshooting

Follow the troubleshooting guide below to resolve common issues.

Issue	Possible Cause	Solution
My air conditioner is not functioning at all	Unit is not receiving power	Make sure the unit is plugged in
	LCDI power cord is tripped	Press the Reset button on the LCDI cord
	Insufficient power	Move the unit to another outlet. Check your circuit breaker. (Refer to the rating label on the back of the unit to determine the Amperage draw)
	Water reservoir is full	Drain the unit and restart
	Control panel is disconnected	If no indicator lights turn on, contact customer service
My remote control does not work and the indicator symbols on the remote do not appear	Batteries not installed	Install new batteries
	Bad batteries	Replace the batteries
	Batteries installed incorrectly	Reinstall the batteries correctly
	A defective remote control	Contact customer service
My air conditioner is making a loud noise	The unit is not level.	Make sure the unit is on a level surface
	A foreign object has jammed the fan.	Remove the object from the fan
	The floor below the unit is uneven	Move the unit to a level surface
My air conditioner is making a continuous metallic knocking or pinging sound	Unit may have been shipped on its side	Shut off the unit. Let the unit sit on a level surface for at least 24 hours and restart.
	Damaged compressor	Contact customer service
My air conditioner is leaking	Drain plug is removed	Attach the drain plug
	Cracked base pan	Contact customer service
My air conditioner runs for a little while and then it trips the power cord or the circuit breaker	The air conditioner may be plugged into an outlet that can not supply the correct amount of current	Contact an electrician if the unit works in a different room or circuit
The front control panel lights blink red	Your water reservoir is full.	Drain your unit.

Troubleshooting continued

Issue	Possible Cause	Solution
My air conditioner is not cooling at all	Unit is not operating in cooling mode	Set the unit to be in cooling mode, and lower the set temperature (pg. 10)
	The compressor is not on	The compressor may take up to 3 minutes to turn on, or longer if it is too warm
	The ambient temperature is too high	Lower the room temperature to be below 90°F degrees
	The filter may be dusty or blocked	Clean the filters. (pg. 14)
	Blocked exhaust port	Remove any obstructions in the exhaust hose and port
My air conditioner blows cold air, but does not lower the room temperature	The unit is not vented	The unit must be vented. (pg. 4)
	The area of the room is too large	Minimize the size of the area to be cooled, i.e. adding a drop ceiling. Use more than one unit to cool the area, or use a larger unit
	Open windows and doors	Close any open doors and windows
	Too many heat sources	Remove or shut off additional heat sources such as radio equipment, servers, etc.
	The room/garage may be inadequately insulated	Properly insulate the room to be cooled, i.e. using fiberglass
	The ambient temperature is too high	The unit may not work if the room temperature is above 90°F
	Direct sunlight is heating the room	Close curtains or pull down blinds, and minimize the direct sunlight into the room
	The filter may be dusty or blocked	Clean the filter and replace it if needed
	Dirty condenser coils	Carefully vacuum the coils clean
	Obstructed air intake or exhaust ports	Remove anything blocking the ports

NOTE: If the ambient temperature is above 90°F the unit may not blow cold air.

TIP: Run the unit before it is needed. For example, run the unit in the morning before the area gets hot, and continue to run the unit all day long in order to maintain a low temperature.

Specifications

Description of product	Portable Air Conditioner
Model	AP12005ECO
Voltage/Frequency	115V/60Hz
Input Power	900W
Current	9.5A
Color	Silver
Coolant	R410A
Timer	24 Hour
Dimensions H x W x D	30.9" x 17.1" x 15"
Weight	67 lbs

EdgeStar Limited Warranty

One (1) Year Parts & Ninety (90) Days Labor

This product is warranted by EdgeStar to be free from defective workmanship and materials, subject to any conditions set forth as follows:

WHAT IS COVERED:

LABOR: For a period of NINETY (90) DAYS from the date of original purchase, labor will be performed free of charge at an authorized EdgeStar repair facility. At its option, EdgeStar will repair the product with new or remanufactured parts, or exchange the defective product with a new, refurbished, or remanufactured product. If a product is replaced, it will carry the remaining warranty of the original product. After the ninety (90) day period, EdgeStar will no longer be responsible for labor charges incurred. All defective products and parts covered by this warranty will be repaired or replaced on a mail-in basis to an EdgeStar authorized repair facility.

PARTS: For a period of ONE (1) YEAR from the date of original purchase, EdgeStar will supply new, rebuilt, or refurbished parts free of charge. EdgeStar may request a defective part be returned in exchange for the replacement part. All replacement parts or products will be new, remanufactured, or refurbished. All products and parts replaced by EdgeStar under warranty service become the property of EdgeStar.

This warranty applies to the original purchaser only, and only covers defects in workmanship experienced during operation of the product under normal service, maintenance, and usage conditions. This warranty applies to the purchase and use of this product in residential settings within the United States of America.

WHAT IS NOT COVERED:

The following limitations apply to the coverage of this warranty. This warranty does not cover:

- Labor charges for installation, setup or training to use the product.
- Shipping damage, and any damage caused by improper packaging for shipment to an authorized service center, and any damaged caused by improper voltage or any other misuse, including abnormal service, handling, or usage.
- Cosmetic damage such as scratches and dents.
- Normal wear and tear on parts or replacement of parts designed to be replaced, e.g. filters, cartridges, batteries.
- Service trips to deliver, pick-up, or repair, install the product, or to instruct in proper usage of the product.
- Damages or operating problems resulting from misuse, abuse, operation outside environmental specifications, uses contrary to instructions provided in the owner's manual, accidents, acts of God, vermin, fire, flood, improper installation, unauthorized service, maintenance negligence, unauthorized installation or modification, or commercial use.
- Labor charges incurred 91 days or more after the date of original purchase.
- The use of EdgeStar products in commercial settings.
- Optional accessories, attachments, and appearance items.
- Products that have been modified to perform outside of specifications without the prior written permission of EdgeStar.
- Products lost in shipment, or theft.
- Products sold AS IS or from an unauthorized reseller.
- Products that have had their serial numbers removed or defaced. Products with serial numbers that have been invalidated.

OBTAINING WARRANTY SERVICE:

If you believe your product is defective, contact EdgeStar Customer Support for troubleshooting assistance and warranty service at 1-866-319-5473. Please have your serial number and proof of purchase available. Once an EdgeStar authorized representative has confirmed that your product is defective and eligible for warranty service, the product must be returned to an EdgeStar repair facility. The purchaser is solely responsible for prepaying all shipping related costs to and from the repair facility. EdgeStar is not responsible for damage resulting from shipper mishandling or improper packaging. Do not return a defective product to the place of purchase. Products received without a return authorization number will be refused.

THIS WARRANTY IS IN LIEU OF ANY OTHER WARRANTY, EXPRESS OR IMPLIED, INCLUDING WITHOUT LIMITATION, ANY WARRANTY OF MERCHANTABILITY OR FITNESS FOR A PARTICULAR PURPOSE. TO THE EXTENT ANY IMPLIED WARRANTY IS REQUIRED BY LAW, IT IS LIMITED IN DURATION TO THE EXPRESS WARRANTY PERIOD ABOVE. NEITHER THE MANUFACTURER NOR ITS DISTRIBUTORS SHALL BE LIABLE FOR ANY INCIDENTAL, CONSEQUENTIAL, INDIRECT, SPECIAL, OR PUNITIVE DAMAGES OF ANY NATURE, INCLUDING WITHOUT LIMITATION, LOST REVENUES OR PROFITS, OR ANY OTHER DAMAGE WHETHER BASED IN CONTRACT, TORT, OR OTHERWISE. SOME STATES DO NOT ALLOW THE EXCLUSION OF INCIDENTAL OR CONSEQUENTIAL DAMAGES, SO THE ABOVE EXCLUSION MAY NOT APPLY TO YOU. THIS WARRANTY GIVES YOU SPECIFIC LEGAL RIGHTS. YOU MAY HAVE OTHER RIGHTS THAT VARY FROM STATE TO STATE.



EdgeStar Products
Box 81336
Austin, TX 78708-1336

Toll Free: 1-866-319-5473
Web: <http://www.edgestar.com>
E-mail: service@edgestar.com

Register your product, download owner's manuals, access additional troubleshooting resources, and obtain more information on other great EdgeStar products on the web at: **<http://www.edgestar.com>**

Product contents and specifications may change without notice.

Copyright © 2009 Living Direct, Inc.